

EX LIBRIS

UNIVERSITY OF
CALIFORNIA

ELECTRICITY

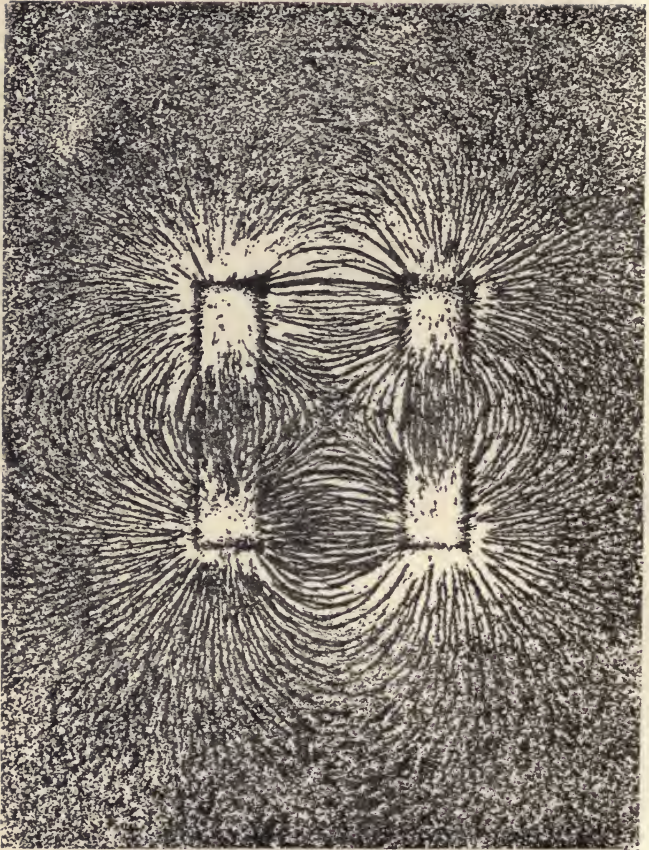

FIG. 2.—Magnetic lines of force of a pair of bar magnets, exhibited by means of iron filings.

SCIENCE IN THE SERVICE OF MAN

ELECTRICITY

BY

SYDNEY G. STARLING

A.R.C.Sc., B.Sc., F.Inst.P.

HEAD OF THE DEPARTMENT OF PHYSICS IN THE WEST HAM MUNICIPAL COLLEGE
AUTHOR OF "ELECTRICITY AND MAGNETISM FOR ADVANCED STUDENTS"; "INTRODUCTION
TO TECHNICAL ELECTRICITY." JOINT AUTHOR OF "TEXT-BOOK OF PHYSICS."

WITH 127 ILLUSTRATIONS

LONGMANS, GREEN AND CO.

55 FIFTH AVENUE, NEW YORK

39 PATERNOSTER ROW, LONDON, E.C.4

BOMBAY, CALCUTTA, AND MADRAS

1922

All rights reserved

RECEIVED
MAY 19 1942

RECEIVED

QC519
57

PREFACE

THE success of the author of "Chemistry in the Service of Man" in showing how the science of chemistry arose and explaining the position of chemistry to-day has encouraged the writer to perform a similar task for electricity. The difficulty presented in this case lies deep in the subject itself, for most of the developments of the last eighty years are mathematical in character. In order to get over this difficulty two methods have been adopted, simple explanations have been given of the physical processes involved, and whenever necessary the terms used have been explained briefly at the end of the book.

The development of knowledge for its own sake is one of the highest services that can be rendered to man, and no branch of science is richer in intellectual achievement than electricity. The subject therefore exhibits in a particular degree that reaction between pure and applied science which is vital to the life of both. The writer has tried to show that the fostering of the study, teaching, and research in pure science is essential to the community which desires to retain its pre-eminence in industry.

It is not necessary to mention any particular development of the applications of electricity to emphasize its importance at the present time. One need only contrast for a moment the daily life in a civilized community at present, with that of two generations ago, when every message had to be carried personally, and communities were cut off from communication with each other, except by methods which required weeks and often months for their accomplishment.

No attempt has been made to give the latest forms and types of apparatus or methods, as such may be found in the current press; but the book endeavours to impart to the general reader,

and to the worker in other branches of science, some comprehension of the subject of electricity as it appears to the physicist of to-day.

I must express my thanks to Messrs. Longmans, Green & Co. for their loan of many diagrams, and to those Institutions which have so kindly lent illustrations, and in particular my thanks are due to Mr. J. W. Allen and Mr. J. C. Allen for their kindly and generous suggestions throughout the production of the book.

S. G. S.

WEST HAM,
February, 1922.

LIST OF PLATES

PLATE		FACING PAGE
	FIG. 13.—Electro-magnet for lifting heavy masses of iron . . . [From the "Journal" of the Institution of Electrical Engineers.]	
I.	FIG. 24.—24-kilowatt motor-generator, with front view of the four-pole direct-current dynamo [From the "Journal" of the Institution of Electrical Engineers.]	22
	FIG. 28.—15 H.P. series motor with slip coupling to call attention to overload [From the "Journal" of the Institution of Electrical Engineers.]	
II.	FIG. 64.—Single-line Murray transmitter [From the "Journal" of the Institution of Electrical Engineers.]	104
	FIG. 123.—(a) Fracture of shaft of humerus by bullet. Bullet lying between fragments [From Kaye's "X-Rays."]	
III.	FIG. 123.—(b) Fragmentation of ulna by shrapnel [From Kaye's "X-Rays."]	206
	FIG. 124.—Coolidge X-ray tube in lead glass shield	
	FIG. 120.—(a) Photograph by C. T. R. Wilson of the path of a beam of X-rays through air supersaturated with water vapour, showing the kathode or β -ray tracks produced. Magnification $2\frac{1}{2}$ diameters. [From the "Proceedings" of the Royal Society.]	
IV.	FIG. 120.—(b) Photograph by C. T. R. Wilson of the path of a beam of X-rays in air supersaturated with moisture. Magnification 6 diameters [From Kaye's "X-Rays."]	218
	FIG. 126.—Photograph by C. T. R. Wilson of the track of an a particle from radium through air supersaturated with water vapour [From "Proceedings" of the Royal Society.]	

CONTENTS

CHAPTER I

HISTORICAL

	PAGE
Beginnings of Electricity—Lodestone and the magnet—Galvanism— Lines of force—Magnetic compass—Magnetic fields and electric currents—Electrolysis—Electrostatics	I

CHAPTER II

THE ELECTRO-MAGNET

Coils and Solenoids—Molecular theory of magnetization—Electro- magnets—Electric brakes—Electric clocks—Electric bells—Electri- cally driven tuning-forks—Magnetic separation of minerals	18
--	----

CHAPTER III

THE DYNAMO

Faraday's laws of induced electromotive force—Continuous production of current—Armatures—Direct-current dynamo—Three-wire system of distribution	30
--	----

CHAPTER IV

THE ELECTRIC MOTOR

Force on a current in a magnetic field—Converse functions of dynamo and motor—Back electromotive force—Starting resistances—Motors used as brakes—Motor power-meters	39
--	----

CHAPTER V

ALTERNATING CURRENTS

Economical distribution of electric power—Induction coil—Transformers —Electric welding—Alternators—Arago's experiment—Induction motors—The magneto	50
---	----

CHAPTER VI

ELECTRIC LIGHTING

	PAGE
Incandescent lamps—Carbon filament—Metallic filament—Tungsten lamps—Electric arc—Automatic arc lamp—Flame arc lamp . . .	74

CHAPTER VII

THE ELECTRIC TELEGRAPH

Early systems—Morse code—Sounders and relays—Railway receiver—Siphon recorder—Duplex telegraphy—Diplex telegraphy—Quadruplex and multiplex telegraphy—Wheatstone's automatic telegraph—Murray printing telegraph—Atlantic cable	91
---	----

CHAPTER VIII

THE TELEPHONE

Bell telephone—Carbon microphone—Receivers—Induction coil—Jack and plug—Attenuation and distortion—Loading coils	110
--	-----

CHAPTER IX

ELECTROLYSIS AND BATTERIES

Early discoveries—Faraday's laws of electrolysis—Dissociation theory—Voltmeters—Electroplating—Electrotyping—Simple cell—Polarization—Daniell's cell—Standard cells—Leclanché cell—Storage cells or accumulators	125
--	-----

CHAPTER X

ELECTROMAGNETIC THEORY AND WIRELESS TELEGRAPHY

Oersted—Faraday—Maxwell—Oscillatory discharge of condenser—Electromagnetic waves—Radiation from aerial—Wireless sending—Alternators—Damped and undamped waves—Quenched spark—Singing arc—Detectors—Crystal and valve rectifiers—The triode as amplifier—The triode as generator—Wireless telephony—Aerials—Transmission of sounds by beam of light	145
--	-----

CHAPTER XI

GASES AND X-RAYS

Vacuum tubes—Discharge at high vacuum—Kathode rays—Ionization—Electrons—Canal rays—Isotopes—X-rays—X-ray tubes—Radio-graphs—Thermions—Wave-length of X-rays	189
---	-----

CHAPTER XII

RADIOACTIVITY

Becquerel's discovery—Radium—Thorium—Actinium— α -rays— β -rays— γ -rays—Radioactive changes—Radioactive series—Production of heat	209
Electrical terms in general use	231
INDEX	241

ELECTRICITY

CHAPTER I

HISTORICAL

FROM the very smallest of beginnings the science of electricity arose. The simple experiment of rubbing a piece of amber with wool and watching light bodies dance up to it, had provided an amusement for centuries before its importance was suspected. The turning to the pole of a balanced piece of lodestone, though of more practical use than the experiment with the amber, was not considered of great importance. Yet unexplained and unimportant effects are sometimes the only outward expression of great and universal laws. The growth of the other branches of physical science causes no surprise. The possession of the sense of sight renders the development of the science of optics or light almost a necessity, for every inquiring mind must seek for explanation of the agency which produces vision, since the phenomena connected with it are of perpetual occurrence. Sound or acoustics naturally follows from our sense of hearing ; and warmth or heat, with the accompanying effects of combustion, expansion, and contraction, have given us a similar study. From the various forms in which matter can occur, chemistry has arisen.

But no one could connect the experiments of the amber and the lodestone with any particular organ of sensation ; they remained mysteries until, early in the last century, newly discovered effects led to a connection between these and others, and from them an abstract idea was evolved

which should unify them all. Such is the normal development of science ; from single and apparently unconnected effects, hypotheses are laid down, which, on being put to the test of further experiment, are verified, or, as frequently happens, are modified, until with fuller understanding it is seen that some underlying principle connects them all. But electricity laboured under the great disadvantage with respect to the other sciences, that the human frame does not possess any sense organs which detect the presence of electrification or magnetization.

No one could have thought a century or so ago that the two simple effects with the amber and the lodestone would eventually lead to the vast organization of industry and research which goes under the name of electrical engineering, or to the explanation of such varied phenomena as light and chemical affinity ; or lead to the discoveries of radioactivity in which new elements are seen in the act of being evolved from others ; or the world atmosphere threaded with a maze of signals carrying messages, and even the human voice, from continent to continent. On looking back, the science which we call **Electricity** is seen to have grown in a manner more marvellous than any of the other branches of knowledge. The growth at first was slow, but by the patient work of the earlier experimenters, the foundations were laid which gave rise to the marvellous progress of the last thirty years. It is our object in this little book not to trace the history of electricity, but to give some intelligent account of its present position. But it follows that simple ideas must be studied before those which are more complex can be grasped, and since the science itself must be developed from the elementary to the abstruse, it follows that every intelligible treatment must be historical to some extent.

From the earliest times it has been known that amber (*ἡλεκτρον*) when rubbed with dry cloth or fur exhibits the property of attracting light bodies. Later it was found that other substances, such as sealing-wax and glass, had the

same property, but the actual origin of the discovery is lost in antiquity. William Gilbert, at the close of the sixteenth century, attributed these effects to a force which he called *electric*. Thus the word *electricity* had its origin ; but it is now known that the cause of these simple phenomena is also the cause of other and far more complicated effects.

The discovery that a certain mineral, oxide of iron, or lodestone, will, when freely suspended, set in one particular direction is of very early origin and was certainly known to the Chinese many centuries ago. The mineral was found at Magnesia in Asia Minor, from which is derived the modern term, *magnet*, that is applied to it when used as described. The mineral is likewise called *magnetite*. On suspending a piece of magnetite, either by hanging it up by a silk fibre, or by floating it upon a piece of wood on water, the piece turns round until a certain part of it is directed towards the north, the opposite part towards the south. The usefulness of this phenomenon was known in the Middle Ages, when this device was used in the form of the magnetic compass or mariner's compass. Although the direction indicated by the compass is not everywhere true north and south, the constancy of the indication of the compass is sufficient for it to be of considerable assistance in navigation. In fact, it is still the chief guide in the steering of all ships, although it has been so modified that a modern ship's compass bears very little resemblance to the suspended lodestone of the ancients. The reason why the discovery of the magnet is included as one of the origins of *electrical* knowledge may not be clear to the reader. For years, even centuries, the phenomenon exhibited by amber and that exhibited by lodestone appeared to have no relation to each other. However, the whole tendency of modern work in this subject makes it more and more evident that magnetism and the electric current are inseparably connected and probably never occur apart. And further, it will become evident as we proceed, that the most useful and beneficial effects of the electric current are

possessed on account of its magnetic properties. This is so true that it may even be doubted whether the two subjects should be separated as is customary, and whether the consideration of magnetic properties as apart from electricity is permissible.

A third origin of our knowledge of electricity can be more definitely dated than the two already mentioned. It is the accidental discovery by Luigi Galvani in 1780 that on touching one of the chief nerves of a freshly dissected frog with the point of a scalpel, at the time that the prime conductor of an electrical machine in the neighbourhood was discharged, the limbs of the frog were violently convulsed. In order to investigate the effect of atmospheric electricity upon the nerves of the frog, specimens were hung up out of doors on an *iron* lattice by means of *brass* hooks passing through the spine. Galvani found that on pressing the *brass* hooks into an *iron* lattice, convulsion of the limbs of the frog took place. It was eventually found that when the muscles and nerves were connected by any external metallic circuit, part of the circuit consisting of one metal and the other part of a second metal, convulsions always occurred. Whenever the circuit consisted partly of a non-conductor of electricity, such as wood, wax, etc., there were no convulsions.

This is a prime discovery, because up to that time electricity had only been produced by friction. The effects produced by the contact of different metals, or of metals and certain liquids was long known as **galvanism**, and the term still remains in the names **galvanic battery** and **galvanometer** and the verb **to galvanize**, both in the sense of exciting to activity, and in the sense of **galvanizing** sheet iron.

Galvani failed in his attempts to intensify the effect by increasing the size of the pieces of metal he used in the circuit, although some pairs of metals were found to be more efficacious than others. It remained to Alessandro Volta in 1800 to find a means of intensifying the Galvani

effect. By taking a number of discs of copper, zinc, and moistened pasteboard, and building them up into a *pile* in the order copper-pasteboard-zinc-copper-pasteboard-zinc, etc., a very much magnified galvanic effect could be obtained, and by touching with one hand the lowest copper disc, and at the same time touching the uppermost zinc disc with the other hand, a distinct shock could be felt, similar in character to that caused by an accumulated electric charge produced by frictional means.

Our knowledge of electricity may be traced from these three humble origins. As in all other branches of knowledge, progress has been made by patient and industrious workers who pursued their labours with no thought to the possibility of their commercial application. It is true that the technical application of scientific principles has led to an enormous development of their everyday usefulness, but the fact cannot be too frequently emphasized that such application has not given rise to any new principle. The discoveries that have revolutionized modern thought and life might all have been called useless and worthless by the people who consider nothing of value that does not lend itself at once to commercial use.

As an intellectual study, electricity presents a field for the highest and most complex types of mathematics, as well as for the reasoning powers of the more direct and realistic type. As an interesting study to those who, without special mathematical training, wish to follow its more practical aspects, none presents so rich a field. The experimenter may find useful material everywhere. A few dry cells and some insulated wire afford more variety for interesting experiment than anything else obtained with as little trouble, while, on the other hand, the following of complex apparatus used in the more abstruse branches of the subject afford difficulties sufficient to satisfy the most intellectual.

Electricity, then, belonged to one of those apparently useless and inexplicable though interesting phenomena

down to the time of Michael Faraday, who in 1831, after long seeking, found the most important link between electric and magnetic phenomena, to which the possibility of producing electric power by mechanical means is due. In order to put the reader in possession of the knowledge necessary to understand this effect, a brief review of the chief electric and magnetic phenomena will now be given. But in order to present this in the clearest manner, the historical order of the discovery of these phenomena will not be followed.

Starting with the simplest phenomenon in magnetism—the setting of the lodestone or natural magnet in one direction and its picking up of iron filings,—it may next be observed that the filings cling more particularly at two places on the body. These are also the places which point north and south when the specimen is suspended, and were discovered by Petrus Perigrinus (1269), who called them **poles**. The pole which points to the north when the specimen is suspended is called the north-seeking or N. pole, and the other the south-seeking or S. pole. The production of artificial magnets led to the discovery of the force between magnetic poles by John Mitchell (1750). If a rod of hard steel be rubbed from one end to the other with the pole of a piece of lodestone, the rod itself becomes a magnet and exhibits all the magnetic properties of the lodestone. There are now other much more powerful means of magnetizing steel, which we shall see later, but the strong magnets so produced are identical in properties with the early forms, the only difference being that of strength.

On obtaining two magnets and suspending one of them by a fine thread, or floating it on wood upon water, and approaching the other magnet to it, using each pole in turn, it will be seen that two N. poles repel each other, that is, there is some force pushing them apart. In the same manner two S. poles repel each other, but a N. pole and a S. pole attract each other. Thus the fundamental law upon which the study of magnetism rests, is that magnetic

poles of like kinds repel each other, and poles of unlike kinds attract each other.

On placing a compass needle near a magnetized bar of steel, the N. pole of the compass is attracted by the S. pole of the bar magnet and repelled by its N. pole. Likewise, forces in the reverse directions act upon the S. pole of the compass. Under these forces the compass will come to rest in some particular direction, and by testing at various positions near the magnet, it soon becomes obvious that the directions are related to each other in a very beautiful manner. The bar magnet being represented by NS in

Fig. 1, the direction in which the small compass will set is shown at *ns*. By moving the compass about, lines round the bar magnet may be found, such that wherever the compass may be placed, its direction is always that of the line on which it happens to be situated. The lines

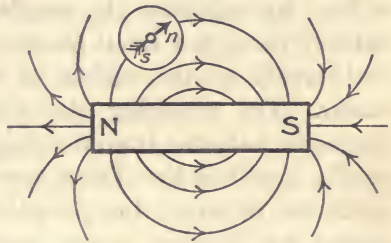

FIG. 1.—Determination of the magnetic lines of force due to a bar magnet by means of a compass.

must, from the nature of the forces between magnetic poles, arise on the N. poles, spread out, and eventually converge on the S. pole. These lines may be exhibited in a very elegant manner by placing a piece of paper or a sheet of glass on the magnet, and sprinkling iron filings on the sheet. On gently tapping the sheet, the filings will arrange themselves along lines similar to those of Fig. 2 (Frontispiece). In this way Fig. 2 has been obtained for a pair of bar magnets situated so that the N. pole of one is near the S. pole of the other. Faraday was particularly struck by the fact that magnetic fields may always be mapped out by means of such lines, and called them **magnetic lines of force**. It is therefore clear that a freely suspended small magnet will always set itself along a magnetic line of force, its

N. pole being urged in one direction along the line, and its S. pole in the opposite direction. Hence Faraday insisted upon the peculiar condition of the space around a magnet, and gave to these lines of force a reality which has proved of first-rate importance in studying magnetic effects. Indeed, it is impossible to overestimate the importance of the effect which the conception of lines of force has had in the study of electricity.

An interesting and simple experiment may be carried out by taking an ordinary sewing needle, which is made of fairly hard steel, and stroking it from the point to the eye with the N. pole of a bar magnet several times. This suffices to magnetize the needle. It may now be pushed halfway through a small piece of cork, so that it will float horizontally on the surface of water placed in a cup or saucer. On removing the bar magnet and all other magnetic materials from the neighbourhood of the floating needle, it will be found that it will soon settle down to one particular direction, the point being directed towards the north; the floating needle constitutes a simple form of magnetic compass. By bringing another needle, similarly magnetized, near to the floating needle the rule for the force between magnetic poles may be established. It will be found that two poles of the same kind repel each other, and poles of opposite kind attract each other. For use as an instrument of precision, the needle takes the form of a little bar of steel, usually tungsten steel, carefully hardened by heating to red heat and plunging in water, before being magnetized. The needle is supported on a steel point or pivot which fits into an agate cup on the needle. In the best patterns the pivot and the cup are of sapphire, the hardness of which causes the retention of a fairly sharp point and minimizes the friction at the point of support.

From very early times there has been much speculation as to why the suspended magnetic needle should point north and south. William Gilbert, in 1600, published a work in which he gave an explanation of the behaviour of

the compass, which was near the truth. He explained its action by saying that the earth itself is a large magnet, and he constructed a model of the earth in the form of a sphere or terrella of magnetite which behaved towards a little magnet placed near it very much as the earth behaves towards the magnetic compass. Such a model of the earth must have the kind of magnetization in its northern half that is possessed by the S. pole of the compass needle, because opposite kinds of pole attract each other. Also the magnetic lines of force would run from one pole to the other, following the course of geographical lines of longitude.

While producing a very fair rough model of the earth's magnetic condition, Gilbert made one mistake of importance ; that is, he considered the magnetic poles of the earth to be at the same places as the geographical poles. Now a careful observation of the position in which a compass needle sets, shows that the needle does not point true north, and that the deviation from the true north varies from place to place on the earth's surface. In England, at the present time, the compass points about 14° west of true north. This amount, called the **magnetic declination**, or by mariners, the **variation of the compass**, is different at different places. Along a line passing through North America, the Gulf of Mexico and the southern Atlantic, the declination is zero, the compass pointing due north. Similarly on the other side of the world is another line of zero declination, although this is more irregular than the American line. Between these two the declination varies, getting greater up to about 20° W. in mid-Atlantic, and 10° E. in mid-Pacific. The lines of equal declination are not regular, like the lines of longitude, but their general course is north and south. The magnetic pole was found by Sir James Ross in 1831 to be situated in Labrador, at a point whose longitude is $96^{\circ} 43'$ W., and latitude $73^{\circ} 31'$ N. ; while the magnetic south pole was found by Shackleton's south polar expedition in 1909 to be situated longitude

155° 16' E., latitude 72° 25' S. Charts are prepared and issued by the Admiralty giving the declination at all points on the earth's surface, and the rates at which it is changing, so that in navigating by the compass, the correction required to reduce a compass bearing to a true bearing may be found.

The mariners' compass in use up to the middle of the last century was very imperfect. It consisted of a card attached to which were the magnets, the card having the points of the compass marked upon it, and a line showing the central line of the ship, or "lubber line," marked upon the case. The old compass cards were both large and heavy and consequently sluggish in movement, and the pivots were so imperfect that sticking of the card was of frequent occurrence. Further, the use of iron in the building of ships introduced new errors, which rendered the compass of very little value, until after the mathematical investigation of the magnetic field on iron ships was made by Poisson and Airy in 1838. After this, the field due to permanent magnetization of the ship was corrected by small permanent magnets placed in the binnacle, and the effect of temporary magnetization of the soft iron in the ship was corrected by means of two soft iron spheres, one on either side of the compass.

The imperfections in the compass itself were not removed until Lord Kelvin, then Sir William Thomson, took up the question, and removed the marked imperfections of the older forms. Lord Kelvin made improvements in two particular directions. First, the card was made very light, being a thin wire ring with a paper disc, cut out in the centre, the points of the compass being marked on the paper. This may be seen in Fig. 3, which is a drawing of a 10-inch Kelvin compass card. The lightness of the card, together with improvements in the pivots, reduced friction to a minimum. Secondly, the magnets were short steel needles, four, six, or eight in number, slung by threads in the central space cut from the card disc. As Kelvin showed, it would require enormous iron spheres to correct

for the soft iron magnetization of the ship with the long magnets of the older type ; but with short magnets the spheres are reduced to a manageable size, and the correction is good. Spheres of 12 ins. diameter are generally employed. The compass is so designed that the period of oscillation of the card is about 30 secs., and is longer than the period of rolling of the ship. In this way the excessive disturbance set up by the rolling of the ship is avoided.



FIG. 3.—Kelvin compass card.

Lord Kelvin produced his type of compass in 1873, and since that time it has been adopted universally for marine service. The only improvement since that time has been the filling of the compass bowl with liquid, which reduces still further the effective weight on the pivot, and also serves to damp out any disturbing oscillation of the card.

With the growth of aeronautics new types of compass have been devised. For the difficulties at sea are as nothing compared with those in the air. When an aeroplane takes a proper turn, the compass does not remain

horizontal, but takes the same tilt as the machine. This introduces further difficulties which up to the present have only been partially overcome. One of the latest types of aeroplane compass is seen in Fig. 4. The light card, with strong magnets, is seen in the centre of a bowl which is nearly spherical, and filled with methylated spirit. The anti-vibration supports are seen, and a small incandescent lamp is placed for use at night, although many of the

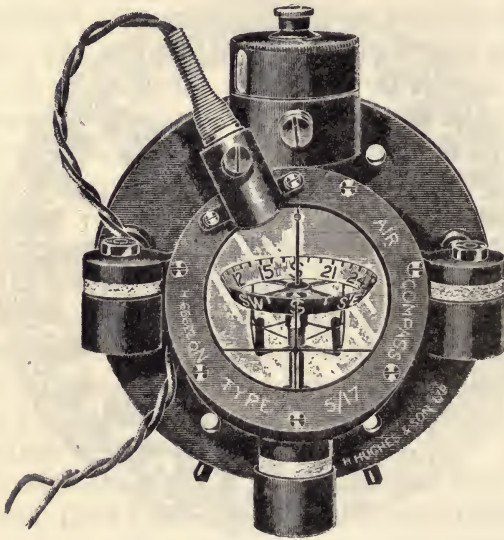

FIG. 4.—Aeroplane compass.

compasses are provided with points marked in radium paint so that they are self-luminous.

We must now take up the thread of our account of the discovery of the electric current itself. If the metallic discs at the end of a voltaic pile (p. 5) are connected together by means of a fine copper wire, it will be noticed that the wire becomes warmed, and if a modern battery be employed instead of the voltaic pile, the wire may be heated to such an extent that it is fused. It was also found that the wire at the same time is capable of

producing an effect upon a magnet. This was discovered by Hans Christian Oersted in 1820, who observed that a suspended magnet tended to set in such a position that it is at right angles to the wire. By these two effects an electric current is recognized. There are other effects due to a current, but the influence upon a magnet and the heating of the wire are the two most important, because these two are employed in nearly all the applications of electricity.

The discovery of Oersted is worthy of particular notice. Owing to its peculiarity it was sought for some time in vain. In all the examples of force between bodies known up to the time of Oersted's discovery, the force is exerted in the line joining the bodies concerned. Thus, in the case of gravitation, two bodies attract each other, and if free to move, will approach each other. Two magnetic poles either attract or repel each other, but the force acting on either is in the line joining the two. A magnetic pole, however, is not attracted towards, or repelled from, a wire conveying an electric current, but experiences a force in a direction at right angles to the current and also at right angles to the line joining the pole to the current. In Fig. 5, if AB is a wire carrying the electric current, a magnetic N. pole situated at C experiences a force urging it in the direction CD , at right angles to both AB and to CE , the perpendicular from C to the wire. If the magnetic pole at C were a S. pole the force would be in the direction opposite to CD , but would still fulfil the stated conditions. It follows, therefore, that a magnet, which of course has a N. pole at one end and a S. pole at the other, would, if

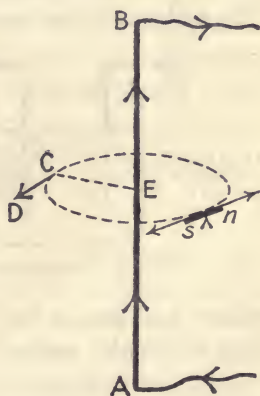

FIG. 5.—Magnetic field due to a straight wire in which an electric current is flowing.

suspended, set as shown at *ns* in the diagram; in fact, a straight wire carrying an electric current is surrounded by magnetic lines of force which are circles having their centres upon the wire.

One other effect of an electric current, which was discovered by William Nicholson and Anthony Carlisle in 1800, must be mentioned. On setting up the first voltaic pile made in this country (in order to repeat Volta's experiments) and completing the circuit by a drop of water, gas was evolved where one of the wires entered the water, the other wire becoming oxidized. On using platinum wires to dip into the water, gas was evolved at both wires; the gas collecting on one being hydrogen, and that on the other oxygen.

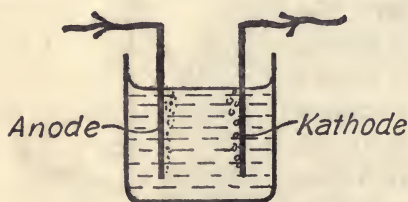
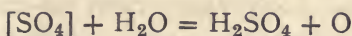

FIG. 6.—Electrolytic cell.

This process was afterwards called **electrolysis** by Faraday, and the liquid through which the current passes an **electrolyte**, and the conductors by which the current enters and leaves the liquid, **electrodes**. With the exception of liquid metals, such as mercury, the only liquids which are capable of conducting an electric current are solutions of certain salts and acids, and the salt or acid is decomposed as the current passes. The hydrogen on the metal is always liberated at the electrode by which the current leaves, which is called the **kathode**, and the acid radicle is liberated at the electrode by which the current enters, which is called the **anode**. In Fig. 6 the anode and kathode are shown. If we consider a typical electrolyte, such as a solution of sulphuric acid (H_2SO_4) in water, the hydrogen (H_2) of the sulphuric acid is liberated at the kathode, and being a gas it bubbles away. The $[SO_4]$ being the acid radicle is liberated at the anode. But this is a substance which cannot exist alone, and with the water it forms again sulphuric acid. The water, being a

compound of hydrogen and oxygen (H_2O), gives up its hydrogen to the sulphuric acid, thus—



The oxygen being a gas forms bubbles which escape through the liquid, but it should be noticed that the oxygen is not produced by electrolysis, as was originally thought, it is the result of the reaction of the $[\text{SO}_4]$ liberated by electrolysis with the water of the electrolyte.

In many cases of electrolysis the substance deposited is in the metallic form. Thus, if the electrolyte consists of a salt of copper, silver, or gold, the metal liberated at the kathode is in the pure metallic form. On choosing a suitable body on which to deposit the metal, this body becomes coated with the metal, and is said to be **electroplated**. The industrial process of electroplating and electrotyping need only be mentioned here in order to indicate the important uses to which the knowledge has been put. It will be described more fully in a later chapter.

It may, however, be noted that one of the earliest discoveries made by means of electrolysis is due to Sir Humphry Davy, who passed the current through fused soda. A metallic bead was formed at the kathode, which was thus the newly discovered metal sodium. Potassium was in the same way liberated from fused potash.

One of the most important investigations of Faraday was undertaken to find out whether the two electricities, that produced by friction and that produced by a battery, were one and the same. He succeeded in establishing the fact that the two were identical, and that every effect produced by one could, under suitable conditions, be produced by the other. The electricity produced by friction is at rest upon the body on which it makes its appearance. But whereas some bodies are incapable of allowing the electricity to move upon it, others allow it to pass easily from one place to another. The former are called **insulators** or **dielectrics**, and amongst the most important of them we

may note : dry air, amber, paraffin wax, mica, gutta-percha, silk, and shellac. Those substances which will allow electricity to pass freely along them are called **electrical conductors**, and, generally speaking, include the metals and certain solutions, which we have seen are called electrolytes. The best conductor of electricity is silver, but pure copper runs it very close. Arranged in order of conductivity, they are : silver, copper, gold, aluminium, zinc, iron, platinum, tin, nickel, and mercury.

Between the good insulators and the good conductors, the great majority of substances would lie, and these are never used for electrical purposes.

Faraday, then, showed that if the electricity produced by friction were placed upon a conductor it could move along it, and in so doing it was capable of producing all the effects due to the electric current derived from a cell or battery, that is, it can produce magnetic and electrolytic effects. But it must not be supposed that the two sources are equally suitable for the production of an electric current. For the current derived from frictional sources is extremely feeble in comparison with that from a battery, although the electricity produced by friction can form a spark by jumping across air spaces of considerable amount. It would require a battery of many thousands of electric cells to cause a spark to jump across an air space a quarter of an inch in length, if the wires had not previously touched, although such a spark can be produced quite easily on rubbing an ebonite rod with a piece of fur and approaching the hand to the ebonite. As an analogy we may liken the current produced by a cell or battery to a river, in which a great quantity of water passes, although the difference of level between neighbouring parts is small. The spark produced from the ebonite must then be considered to be similar to a raindrop which falls from a great height but contains a very small quantity of water.

Electricity at rest exhibits very different properties from electricity in motion. There is no magnetic effect due to

electricity at rest, the study of which is called **electrostatics**. Electricity in motion is called **electric current**, and its most important distinction from electricity at rest is that it is always associated with a magnetic field. A study of the electric current leads to the treatment of all the useful applications of electricity, and it will be our object to trace these from their origin in the laboratory and to see how they are employed for scientific and industrial purposes. In the great majority of these applications of the current, it is the magnetic effect which is of greatest importance.

We have seen that an electric current flowing in a wire produces a magnetic field, and that a piece of iron or steel in this field becomes a magnet and attracts other pieces of iron or steel. Hence the current brings into play forces which may be utilized in various ways. This is, in brief, the principle of the electric telegraph, in which a piece of iron is magnetized by the current and attracts a second piece of iron ; in the telephone, in which the variation in a current causes a variation in magnetization and of attraction between a piece of iron and a thin iron diaphragm ; and it is also the basis of many other electrical appliances. Thus the electric motor, which supplies the motive power for electric trains, trams, and to an ever-increasing amount machinery of all kinds, is one of the most direct applications of the force brought into play between an electric current and a magnetic field. But in order to obtain the current for such purposes, mechanical means are necessary, and these mechanical means find their realization in the electric dynamo. We shall now turn our attention to the electromagnet, that device which is fundamental to nearly all the useful applications of the electric current, and next to the dynamo, and shall see how an important discovery due to Faraday led immediately to the possibility of constructing machines for producing electric power on a sufficiently large scale for commercial purposes.

CHAPTER II

THE ELECTRO-MAGNET

STARTING with the knowledge of the direction of the magnetic field in the neighbourhood of a wire in which an electric current is flowing (p. 13), it is easily seen that if the wire makes a loop, as in Fig. 7 (a), the magnetic lines of force emerge from the coil on one side, travel round externally, and re-enter the coil by the other face. If the

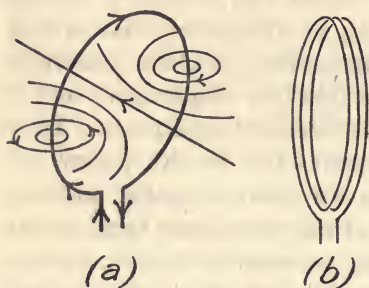

FIG. 7.—Magnetic field due to an electric current in a circular coil.

same strength of current is employed, the magnetic field will be increased by making several turns or loops to the coil (Fig. 7 (b)), for each turn will produce its own effect, whether the other turns are present or not. Thus the magnetic effects of the separate turns of wire must be added together

to obtain the resultant magnetic effect of all the turns. Such an arrangement is commonly employed in constructing a galvanometer for detecting or measuring small electric currents. If a magnetic compass needle be suspended at the centre of such a coil, the very feeble effect of a small current upon it is multiplied many times by using a considerable number of turns. In some sensitive galvanometers several thousands of turns are employed.

Another arrangement of the coil is obtained by placing

the turns side by side, as in Fig. 8, by winding the wire on a piece of tube. Such an arrangement is called a **solenoid**. The magnetic lines of force now pass through the solenoid, emerging at one end A (Fig. 8), spreading out, and re-entering at the other end B. It was shown by Andrée M. Ampère (1823) that a solenoid with an electric current flowing in it, behaves exactly like a magnet; in fact, any current circuit may be imitated in its magnetic effect by an appropriately shaped magnet. But there is this difference between a magnet and a solenoid, that whereas the magnet is solid, and its interior is inaccessible, the solenoid is hollow, and the condition of the interior can be investigated. It is not at all difficult to show, either by means of

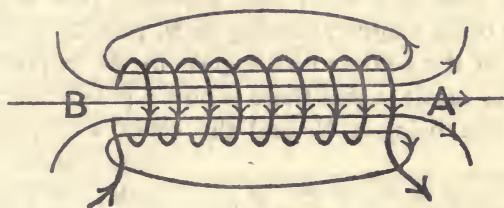

FIG. 8.—Magnetic field due to a solenoid.

a compass needle or by means of iron filings, that the magnetic lines of force in the interior of the coil are as shown in Fig. 8.

It has already been seen (p. 6) that a piece of steel is converted into a magnet by being stroked by the pole of another magnet. The act of stroking merely brings the steel into very close proximity with the magnetic pole employed; the actual contact is in no way necessary for the magnetization produced, which is in marked distinction to the process of electrification by friction (p. 2). The essential condition for magnetization is that the piece of steel shall be placed in a magnetic field. Soft iron is magnetized very easily under these conditions, but readily loses its magnetization when withdrawn from the magnetizing field. Again, if a steel magnet be broken, the parts

are found to have new poles, so that each is a complete magnet having a N. and a S. pole (Fig. 9). These and other well-known facts have led to the idea that magnetizable materials—steel, iron, nickel, and cobalt—consist of

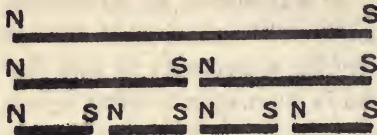

FIG. 9.—Poles produced on breaking a magnet.

minute parts or molecules, each of which is always a magnet. When the material is not magnetized these molecules are set in all directions indiscriminately, as represented

figuratively by the little lines to represent these magnets with arrows to show their N. poles in Fig. 10. But a magnetic field acts upon each molecule just as it would upon any other magnet, causing its N. pole to point in the direction of the field and its S. pole in the opposite direction. The result is that there is now a pole at each end of the bar, one being a N. and the other a S. pole. This

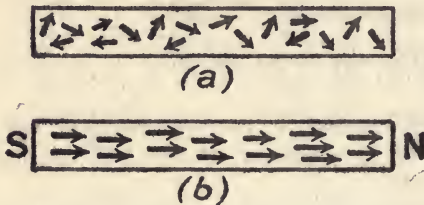

FIG. 10.—Illustration of magnetization.

arrangement is illustrated in Fig. 10 (b), but it must be remembered that the strokes representing the molecular magnets NS are drawn enormously too large; for the actual molecules

are small beyond even microscopic vision. This molecular theory of magnetization is supported by far more evidence than can be given here. It took its rise many years ago, but received its present form from Sir J. A. Ewing, who showed that all the peculiarities in the magnetic properties of iron and steel are consistent with, and can be explained by, such a theory.

Turning again to the solenoid with a current flowing in it (p. 19), the effect of putting a piece of iron inside it becomes evident. The molecular magnets of the iron turn

into the direction of the magnetic field due to the current, and produces magnetic poles at N and S (Fig. 11), which are many times stronger than the poles of the solenoid without iron. It may easily happen that the pole with the iron present is a thousand times as strong as it would be

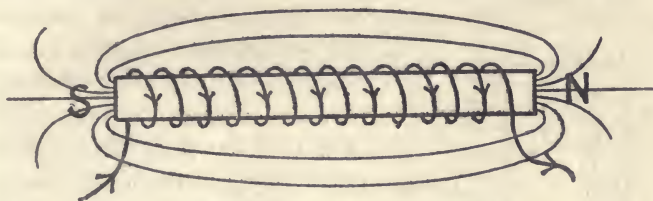

FIG. 11.—Simple electro-magnet.

with no iron present. The use of the iron core to the solenoid is, consequently, of very great importance in practice, the variety of applications of it being innumerable. Such an arrangement of solenoid with an iron core is called an **electro-magnet**, and a few of the more direct applications of the electro-magnet will not be out of place here. Many complex appliances, such as the telephone, induction coil, etc., are dependent upon the principle of the electro-magnet; but there are several direct applications where little more than the electro-magnet itself is involved.

The simple straight form of the electro-magnet seen in Fig. 11 is seldom met with. When the attractive effect of its poles for iron is to be used, increased effect is obtained by applying both poles to the iron. This necessitates bending the core round so that the two poles are near together as at NS (Fig. 12), the solenoid generally being wound upon the straight limbs of the iron. Care must be taken that the winding is continuous, and where the wire passes from one limb to the other, as at AB, it must pass from front to back, or back to front, in order to ensure correct magnetization of the limbs. The core of the electro-magnet must always be made of soft iron, never of hard steel, the reason being that hard steel will retain most of its magnetization when the current in the windings ceases.

This would be in most cases troublesome, because one of the chief advantages of an electro-magnet is that it can be rendered active or inactive by merely starting or stopping the electric current.

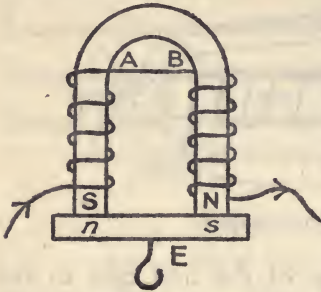

FIG. 12.—Horse-shoe electro-magnet.

The pressing of a key which completes the electric circuit brings into play, by means of the electro-magnet, great forces which last only so long as the key is pressed. The soft iron bar E, known as the armature, is rendered magnetic with poles as shown. It is clear that the attractions between N and s and between n and S pull the armature on to the electro-magnet. The

core may be solid or may be built up of strands of iron wire, which latter arrangement has many advantages over the solid type.

As an apparatus for lifting weights, the electro-magnet is coming more and more into use, and there are several forms for moving masses of iron from place to place. One such arrangement is seen in Fig. 13 (Plate I).

The electric brake employed on trams is of importance,

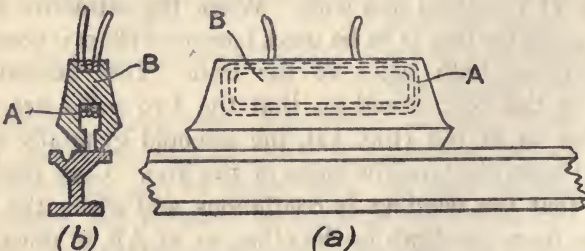

FIG. 14.—Electro-magnetic brake for tram.

because it is very powerful and easily applied. It is nothing more than an electro-magnet carried on the body of the tram, the poles being situated immediately over the steel rail. The arrangement will be seen in Fig. 14, in



FIG. 13.—Electro-magnet for lifting heavy masses of iron.
[From the "Journal" of the Institution of Electrical Engineers.]

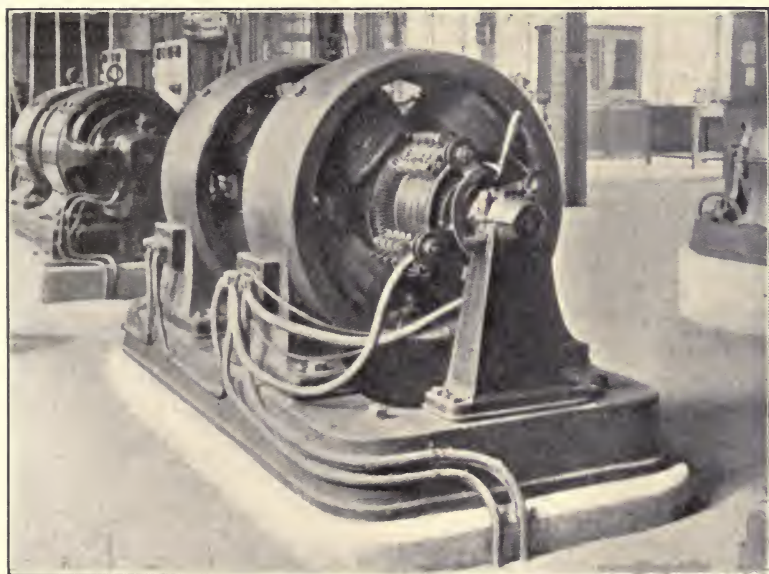

FIG. 24.—24-kilowatt motor-generator, with front view of the four-pole direct-current dynamo.
[From the "Journal" of the Institution of Electrical Engineers.]

which (*a*) is a side view and (*b*) an end view of the brake. When the electric current passes through the coil A the core B becomes magnetized, and since the rail acts as armature it is strongly attracted to the poles of the core. The core is thus forced on to the rail and the friction between the two surfaces gives a very powerful braking effect. This form of brake is very effective on an incline or in an emergency, but acts too violently for ordinary use. The very gentle braking action of the electric motors themselves is used for stopping the tram under ordinary conditions, but this will not hold the tram on an incline, when the friction brake must be applied.

Among the innumerable applications of the electro-magnet, its use in driving and controlling clocks should not be omitted. There are three distinct ways in which this has been attempted, each method having some advantages and some disadvantages with respect to the others. The first method consists in replacing the ordinary driving weight or mainspring of the clock by an electro-magnet or coil which gives an impulse to the pendulum once in each vibration. A current passes through the electro-magnet or coil when the circuit is closed by a contact or key actuated by the pendulum. The energy for driving the clock is therefore derived from the battery which produces the current, and since batteries are somewhat unreliable, and at best require periodical changing, this method has not come into common use. In the second method a regulating or controlling circuit is supplied to a number of clocks, so that regularly timed impulses from a central control clock can affect all the clocks concerned. In some cases the impulse consists of a momentary current, which in passing through a coil at every beat of the pendulum, forces the pendulum to keep to the time interval of the impulses. In other cases the impulse is supplied once in every hour, which by means of an electro-magnet, pulls the minute hand of the controlled clock into its correct position. This amounts to setting the clock right

once in every hour. Both these processes are known as *synchronizing*, or the keeping of the independently driven clocks in time with some standard clock. The disadvantage of the method lies in the fact that if for any reason, such as temporary stoppage, the controlled clock gets badly out of time, the synchronizing impulses cannot set the clock right ; it must be carefully reset.

The third method is also a central control method, but is in addition a central driving method, the current being supplied through electric wires to the separate clocks

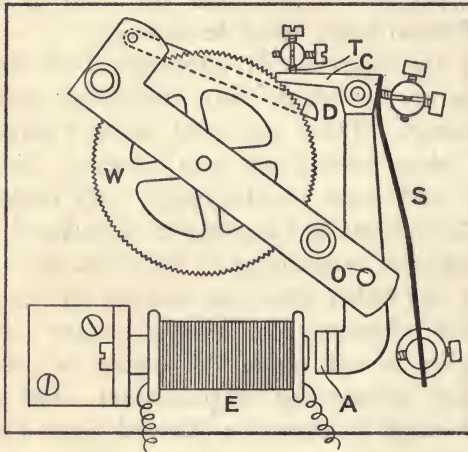

FIG. 15.—Hope-Jones electric movement for clock.

Properly speaking, there is only one clock to this system, and this is situated in some central position, and regulates the sending out of short impulsive currents at frequent and regular intervals. These currents actuate an electro-magnet at each of the dials at which time is to be exhibited, the electro-magnet moving the hands over the dial by an appropriate amount. There are many difficulties in performing this, but Fig. 15 illustrates a device by Mr. F. Hope-Jones which is very efficient, and is adopted by the Synchronome Co. The minute hand of the dial is attached to a wheel W having 120 teeth. A click C is pushed

forward by the spring S and drives W forward through a space of one tooth. When a momentary current from the central clock passes through the electro-magnet E, the iron armature A is attracted; this armature is carried by the same lever that carries C. The lever is pivoted at O, so that when A experiences the pull by the electro-magnet, C is withdrawn from the tooth of W, ready to be pushed forward by the spring when the impulsive current in E is over. The stop T prevents the wheel W being driven forward more than one tooth at a time. Since the impulsive currents in E arrive from the control clock once every half-minute, it will be seen that the minute-hand is moved forward in correct time. The click D ensures the locking of the wheel W while the click C is withdrawn, and thus acts as a back stop. Such systems of central control for clocks are coming into extended use on railways and for other public purposes.

Another simple and important example of the use of an electro-magnet is seen in the case of the common electric bell, Fig. 16. The electro-magnet M is excited by a current entering by the terminal A and passing by way of the steel spring B to the contact C, then through the coils of the magnet M, and out by way of the terminal G. The soft-iron armature H is attracted by the electro-

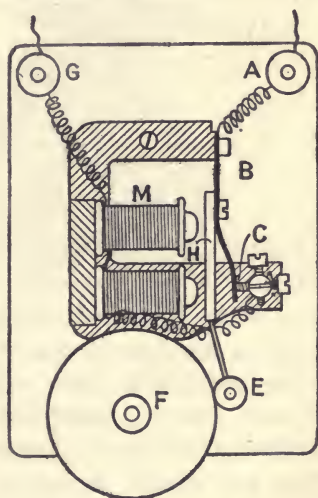

FIG. 16.—Electric bell.

magnet, and so the contact C is broken. It follows that the current is cut off. But interruption of the current means that the soft iron core of the electro-magnet will cease to be magnetized, and it will no longer attract the armature H. The spring B then carries the armature back

to its original position, and contact is made again at C, so that the whole process is repeated. It is therefore seen that, so long as the terminals A and G are connected to a battery, the armature H will vibrate backwards and forwards, and if it is provided with a hammer E which strikes a gong F, the bell will continue to ring. This arrangement of make and break renders the current intermittent, and is used in many cases where an automatic repeated interruption of the current is required. The rapidity with which the strokes of the hammer follow one another in the case of the simple trembler of Fig. 16 depends upon the stiffness of the spring B and the weight of the hammer E; but in this rough arrangement, the frequency of the blows is not

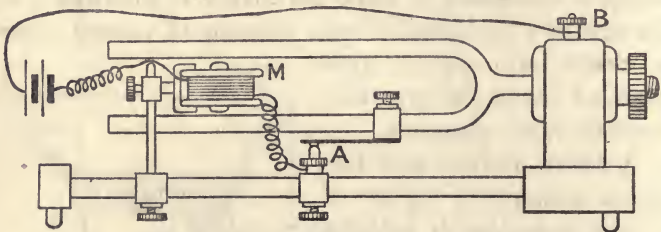

FIG. 17.—Electrically driven tuning-fork.

a matter of great importance. For some purposes a rapid vibration of very constant rate is required, and a modification of the arrangement may then be made. A tuning-fork supplies the body of constant frequency of vibration, and a make-and-break device may be applied, so that the intermittent current maintains the tuning-fork in vibration, while the fork itself causes the interruption of the current. The tuning-fork being of steel, the prongs are pulled together whenever an electric current flows in the electromagnet M (Fig. 17). The raising of the lower prong breaks the electrical contact at A, and of course the cessation of the current allows the prongs of the fork to spring apart again. The actual terminal is not placed on the spring at A, for the connecting wire would then hinder the free motion of the tuning-fork. It is placed at B, on the heavy

metal support, so that the current traverses the stand and tuning-fork itself on the way from the spring to the battery. Such an electrically driven tuning-fork provides an excellent means of maintaining an electrical current, interrupted at constant frequency, such as is employed when the mechanism of the machine telegraph is required to be driven at constant speed.

For experimental work in which very strong magnetic fields are required, for the examination of the magnetic

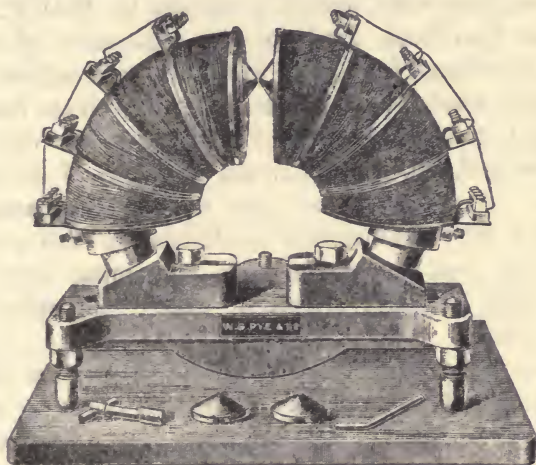

FIG. 18.—Powerful electro-magnet for experimental purposes.

properties of feebly magnetic materials, an electro-magnet of special design is required. One such form of powerful electro-magnet is seen in Fig. 18. Between the tips of the pole pieces, the magnetic field is intense, and has a further property that it falls off very rapidly on proceeding away from the pole tips. This condition of a magnetic field which varies rapidly from point to point is an important one for examining the magnetic properties of certain substances. We have already seen that the three metals, iron, nickel, and cobalt are vastly more magnetic than all other substances, and on this account they are said to be **ferromagnetic**. But nearly all substances are magnetic to some

extent. They group themselves, however, into two classes. One class comprises those substances which tend to move from a weaker to a stronger magnetic field ; these are said to be **paramagnetic**. A piece of a paramagnetic substance placed near the polar tips of the electro-magnet (Fig. 18) is therefore attracted into the stronger field, and a measure of its paramagnetic properties has been made by observing the force which, under definite conditions, draws it into the strongest part of the field. This method has been used by many experimenters, and in particular by Prof. P. Curie, and has also been used for the separation of slightly magnetic minerals from those which are non-magnetic. On the other hand, some substances are driven from the stronger to the weaker parts of a magnetic field and would therefore be forced away from the polar tips of the electro-magnet. Such substances are said to be **diamagnetic**. Amongst the paramagnetic materials we find platinum, aluminium, and many minerals containing iron, while silver, gold, bismuth, antimony, water, and sulphur are diamagnetic.

Many devices have been used for separating the different constituents of mineral ores from each other by making use of their variation in magnetic properties. The Rowland-Wetherill separator is illustrated in Fig. 19. The crushed ore from the hopper H is fed on to an endless belt B driven by two pulleys. It passes between the poles P_1 and Q_1 of two electro-magnets and the magnetic pieces of ore are attracted to the V-shaped pole pieces P_1 where the magnetic field is intense, while the non-magnetic remainder is carried forward and delivered into the receptacle A. Two belts E and F, similar to B but moving at right angles to it, pass one under each pole, and the magnetic particles are pulled on to the under side of the belts and are so carried out of the magnetic field and delivered into the receptacles C and D. By arranging the pole P_2 to have a greater pull than P_1 , the more magnetic particles are drawn up by P_1 and delivered to C, while the stronger pole P_2

pulls up the less magnetic particles, for which P_1 was not strong enough, and these are delivered to D. Thus the arrangement constitutes a double separator, which is used

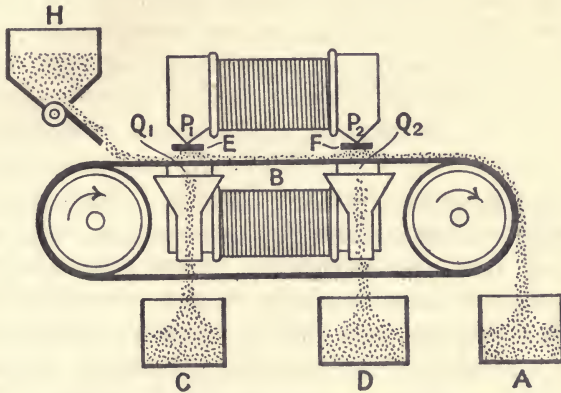

FIG. 19.—Rowland-Wetherill magnetic separator.

to separate the three minerals, ilmenite, monazite, and zircon. The zircon is delivered into the receptacle A, ilmenite into C, and monazite into D.

CHAPTER III

THE DYNAMO

WHEN searching for a possible effect of an electric current upon neighbouring circuits, Faraday made, in 1831, a discovery of first-rate importance. It was known that a magnet caused pieces of iron or steel in its neighbourhood to become magnets, and that electrostatic charges could produce electrostatic charges on neighbouring conductors. Is there, then, a similar property for electric currents? That is, will a current flowing in a conductor produce by its mere presence, an electrical effect in neighbouring conductors? By no arrangement of the conductors could such an effect be produced, but in performing the experiment, Faraday discovered that *on starting* a current in a wire, a momentary current may be produced in a wire near it and parallel to it, provided that this second wire forms part of a complete conducting circuit. It is well known that if this second circuit is incomplete, no current will flow in it. When a current flows on the completion of any circuit we say that there is an **electromotive force** in the circuit. Thus an electric cell or battery such as the voltaic pile is a source of electromotive force, and in this case the chemical changes in the cell are the source of the energy which drives the current.

In Faraday's experiment it is clear that the starting of the first current produced an electromotive force in the neighbouring wire. Further, on stopping the current there is again a momentary electromotive force in the neighbouring wire, but it is in the opposite direction to the electromotive force due to the starting of the current.

Faraday soon traced these effects to the magnetic field due to the first current. This field springs into existence on the starting of the current, and disappears on the stopping of the current, and in either case the magnetic lines of force cut across the neighbouring wire. We say, therefore, that whenever magnetic lines of force cut across a conductor, there is an electromotive force produced which will produce a current if the conductor forms part of a complete conducting circuit. These are called **induced currents** and **electromotive forces**. A simple experiment will show that induced currents and electromotive forces are due to the motion of magnetic lines of force. Many turns of silk-covered copper wire are wound upon a bobbin B (Fig. 20), and the free ends of the wire are connected to a galvanometer G. The galvanometer is itself a vertical coil of wire with a pivoted magnetic needle at its centre. Any current in the coil of the galvanometer will produce a magnetic field which causes a disturbance of the suspended magnetic needle.

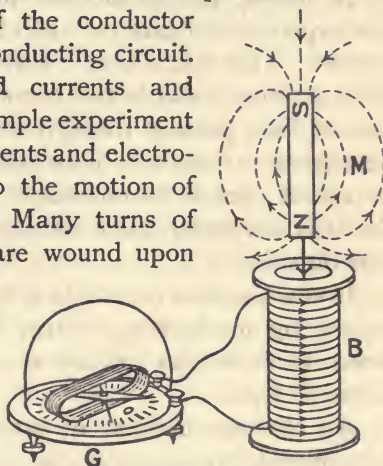

FIG. 20.—Experiment representing the production of current by electro-magnetic induction.

On bringing a bar magnet towards the coil B, and allowing one pole to enter B, a deflection of the galvanometer needle will be observed for the whole time that the magnet is in motion. On withdrawing the magnet another deflection of the needle is produced in the opposite direction to the first. If the magnet remains fixed and the coil B be moved instead, the effect is the same as before, showing that the electromotive force produced is due to the fact that the magnetic lines of force and the wire of the coil cut each other, and the direction of the electromotive force depends upon the direction in which the lines cut the wires.

It may also be observed that if the magnet is pushed rapidly into the coil, the deflection is greater, but of course lasts for a shorter time than when it is done slowly. Consequently the electromotive force is increased by increasing the rate at which the lines of force cut the wire, or the number of lines of force which cut the wire per second.

A simple and useful rule may also be deduced from this experiment if care be taken to note the direction of the current. This rule is that "if we look along the magnetic lines of force towards the circuit, then, if the number of lines of force passing through the circuit is *increasing*, the electromotive force acts in an *anti-clockwise* direction round the circuit; but if the number of lines passing through the circuit is *decreasing*, the electromotive force acts in a *clockwise* direction.

It now becomes clear that it is possible to obtain electric current by mechanical means, by making use of steam power to cause the motion of an electric conductor in a magnetic field.

An obvious method of attempting to make use of this effect is to mount a disc of metal, which must be a good conductor of electricity, on an axle, and to cause it to revolve rapidly in a magnetic field. If a copper disc C (Fig. 21) be mounted on an axle A, so that it can be driven round at considerable speed, and a magnet N be situated

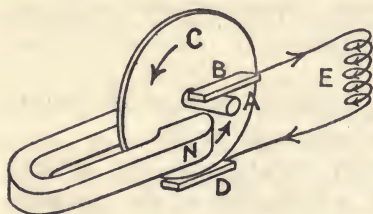

FIG. 21.—Continuous production of current by electro-magnetic induction.

with a pole on either side of the disc, the magnetic lines of force of the magnet pass through the disc. On causing rotation, the metal cuts across these magnetic lines of force, and an electromotive force is produced in the disc. The direction of the electromotive force is at right angles both to the magnetic lines and to the direction of motion, and is therefore directed along the radius of the disc, from the

edge towards the axle. On allowing a strip of metal B to touch the axle and another strip D to touch the edge of the disc, it will be found that a current will flow in a wire E connected to B and D. This is a primitive form of dynamo, and one that was devised shortly after Faraday's discovery of induced electromotive force. It can never, however, be of any great practical use, for although fairly large currents may be produced, if the wire is of sufficiently great conductivity, the electromotive force is too small to be of any practical value. The electromotive force is proportional to the number of magnetic lines of force cut per second, and with a powerful magnet and a disc making 2000 revolutions per minute, it is probable that the electromotive force acting would be less than 1 volt, that is, it is less than the electromotive force of an ordinary cell. It is only by using a number of conductors in series, so that the electromotive force is the sum of those in the separate conductors, that a useful electromotive force can be obtained.

The general mode of doing this is to arrange the conductors, which are bars or wires of exceedingly pure copper, round the circumference of a cylinder mounted on an axle. The copper bars are connected together in such a manner that the current produced can pass through them, and out by means of a sliding contact, to the external circuit, where it is employed for some useful purpose.

Such an arrangement is shown somewhat diagrammatically in Fig. 22, and is called the **armature** of the dynamo. AB is one of the copper bars. These lie in the slots or grooves of an iron core, built up of stampings from iron sheet placed face to face, and keyed on to the axle. The appropriate ends of the conductors are soldered into other copper strips, shown at C, against which the brass or copper brushes D and E bear. This arrangement is called a **commutator**, and the sliding contact between the brushes and the sections of the commutator enable the current to be collected and conveyed to the external circuit. F is the pulley over which the belt from the engine passes, in order

to cause the rotation required. The method of connecting the armature conductors to each other and to the commutator varies with each machine, and is too complicated to enter into here.

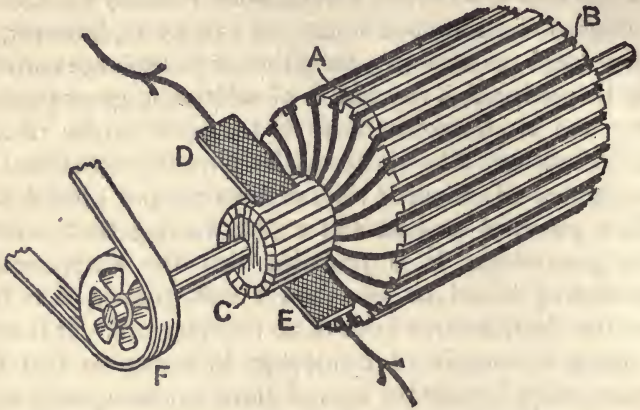

FIG. 22.—Armature and commutator of a direct-current dynamo.

In order to obtain a strong magnetic field in which the armature conductors shall move, electro-magnets are employed in all large machines. These electro-magnets have various shapes, but a simple form is shown in Fig. 23. An end view of the machine, which is called a **dynamo**, is taken for simplicity. The electro-magnet or field magnet is provided with two heavy pole pieces marked N and S, and is magnetized by an electric current passing in the coils on the limbs A and B, bolted into a yoke C. The pole pieces, limbs, and yoke are all constructed of iron, and produce a powerful magnetic field in the cylindrical space between N and S. In this space the armature rotates, and it will be seen that all the armature conductors on the right-hand side are passing down through the magnetic field, while all those on the left-hand side are passing upwards. A method of connecting the armature conductors to the commutator is shown, and by tracing out the connections it can be seen that the current produced by the cutting of the conductors

across the magnetic field will leave the commutator by the brush D, and enter by the brush C. In Fig. 23 the current for the field magnet is the actual current produced in the armature of the dynamo, which also flows in the external circuit. The three parts of the circuit, that is, the armature, the field coils, and the external part, are said to be **in series**, and in this case the machine is called a **series dynamo**. In some cases the current from the armature divides between

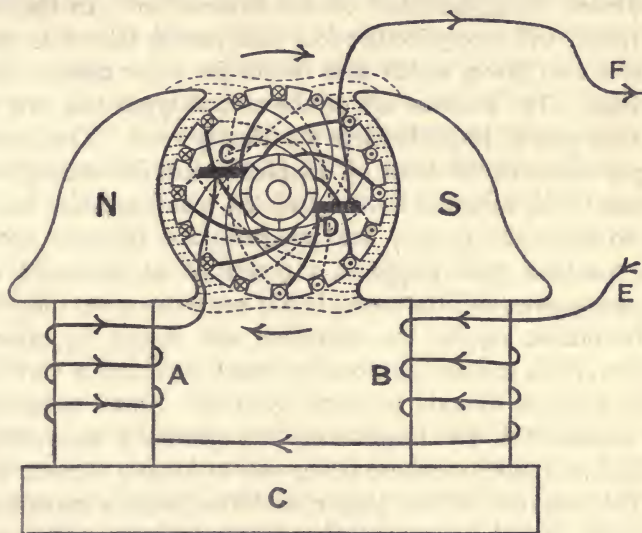

FIG. 23.—Diagrammatic representation of the electrical circuits of a direct-current series-wound dynamo.

the field magnet and the external circuit, when the machine is called a **shunt dynamo**. Sometimes a combination of the two methods is used, when the term "compound winding" is employed.

The actual form of a dynamo will be seen in Fig. 24 (Plate I), in which the field magnet has four poles, alternately N and S; a very common arrangement. In this case the dynamo is driven by an alternating-current motor, but this in no way affects its use as a dynamo, and if driven in any other way, as, for example, by a steam engine, or

as is now a common practice, by a steam turbine, the result would be exactly the same. The pair of machines as seen in the diagram is called a **motor-generator**, and comprises an excellent means of converting power supplied in the form of alternating current into direct current. Of course the actual current is not converted; the alternating current is used to drive the motor, as will be explained in Chapter V., and the dynamo generates the direct current, the two armatures being mounted on the same shaft. In Fig. 24 the reader will recognize the four pole pieces, bolted to the circular iron yoke, which also forms the outer case of the machine. The brushes are of the carbon type, and two of the four sets of brush holders are clearly seen. The stout copper cables at the front of the picture are for leading the current to the external circuit, and the smaller cables leading to the coils of the field magnets are likewise seen. The machine itself produces a power of 24 kilowatts, or 32 horse-power, and the speed is 625 revolutions per minute.

In public supply, the dynamos are driven by steam engines, or in modern stations by steam turbines, a turbine being coupled directly to each dynamo. Small dynamos are self-excited, but large ones are generally separately excited, a smaller machine being run to supply current for the field magnets of the larger, or actual supply machines. At the central supply station several large units are employed which may be connected to the main switch board or disconnected from it as the demand for current fluctuates. The current from the small dynamo which is used to supply the current for the field magnets of the large machines can be controlled by the switch-board attendant, being regulated by him in such a way that the main voltage of supply is maintained very nearly constant. If the voltage drops, owing to the station load increasing, the attendant cuts out resistance from the field current circuit, and so increases the magnetizing current in the field coils of the machines, the effect of which is to raise the voltage.

The supply mains from the central station consist of well-insulated copper wires or cables, laid in conduits under the streets. The cost of these mains is very great, and when the current has to be carried some distance, the mains themselves may cost as much as the rest of the installation, including buildings, engines, and dynamos. It is therefore obvious that any method of keeping down the cost of the mains is of first-rate importance. One such method is to use as high a voltage of supply as possible; for, in order to transmit any given power, the current varies inversely as the voltage. For example, in order to transmit 100 horsepower at 100 volts, the current must be 746 amperes; but in order to transmit the same power at 200 volts, the current would be halved, that is 373 amperes. There is a

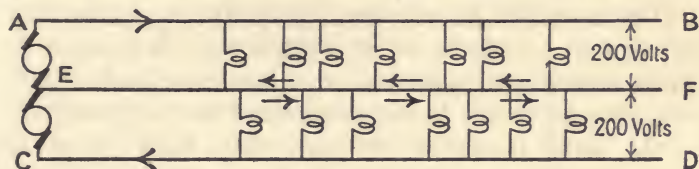

FIG. 25.—Three-wire system of supply for direct current.

limit, however, to the voltage used in public supply, for the danger on account of fire and electric shock to the user increases with high voltages owing to the likelihood of the insulation breaking down. The Board of Trade has therefore fixed the maximum voltage for public lighting supply at 250 volts. One of the commonest voltages of supply is 200. There is another method by which economy in mains is effected; that is by use of the **three-wire system**. By using two dynamos connected to the mains as shown in Fig. 25, and employing three wires AB, CD, and EF, and connecting the load across only one pair of mains, the current for one set leaves by the main AB and returns by EF. The other current leaves by EF and returns by CD. If the two loads are well balanced so that these currents are equal, it will be seen that the resultant or effective current in EF will be zero, and in any case the

current in EF will only be the difference of the currents in the two parts of the installation. Thus EF may be made of very much thinner cable than AB and CD. By placing one consumer's premises across the mains AB and EF, and the next between EF and CD, and so on, the voltage on each supply will only be, say, 200 volts, while the station voltage is 400 volts. Hence economy in mains is effected, for if the two supplies had been carried out by independent mains, four cables each as heavy as AB or CD would have been required.

CHAPTER IV

THE ELECTRIC MOTOR

HAVING seen how Faraday's work led to the possibility of producing current by mechanical means, it is now open to us to follow the various uses of the current. Its application to the production of motive power is perhaps the most appropriate at this stage, because the electromotor is in all respects the counterpart of the dynamo. In fact their functions are reciprocal, one converting mechanical energy into energy of electrical current, and the other converting the energy back again into the mechanical form. One of the chief functions of electricity is to enable energy to be distributed economically and conveniently. Our chief source of energy is coal, whose energy is traceable to the chemical affinity of the carbon and hydrogen, of which it is chiefly composed, for the oxygen of the air. On burning the coal in furnaces, this energy becomes heat, and on being employed to boil water under pressure, the energy can be used for driving the piston of the steam engine backwards and forwards, or for causing rotation directly in the case of the steam turbine. In either case, the mechanical energy produced is employed to produce rotation of the armature of the dynamo and so the electric current arises. By far the greater part of the electric current used is produced at central stations, as its production on the large scale is much more economical than production by small electrical machines. From the central station the current is conveyed by insulated copper conductors or cables to the place at which it is to be usefully employed. Whether for

lighting, heating, or power depends upon circumstances. The public supply from central stations is used commonly for all these purposes.

The advantage of using electrical power for driving machinery, trams, trains, etc., lies in the fact that the power can be supplied conveniently at the point at which it is required, without the intervention of shafting, belts, and pulleys. Also the current can be switched on and off as required. Thus there is no wastage when the machine is at rest, as is the case when a factory is driven by its own set of boilers and engines, and the shafting is always running.

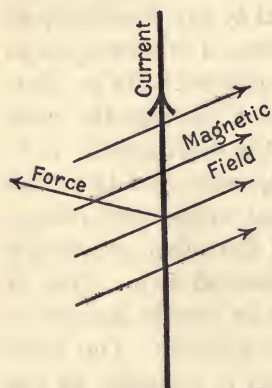

FIG. 26.—Relation between current, magnetic field, and force on conductor.

The electromotor depends for its action upon the reverse effect to that of the production of a current by the motion of a conductor across a magnetic field. If an electric current flows in a conductor which is situated in a magnetic field, and at right angles to the direction of the field, as in Fig. 26, then the conductor will experience a force urging it to move at right angles to both the current and to the magnetic field. This effect can be

seen at once to supply the necessary condition for constructing an electromotor. On referring to Fig. 23, it will be seen that if, instead of applying mechanical power to cause the armature to rotate, a current be applied to the machine, entering at E, passing through the field coils B and A, it will cause the magnetization of the field magnets as shown. Also the current will enter the armature by the brush C, pass through the armature conductors, leaving by the brush D and eventually pass out by the conductor F. Through all the conductors on the right-hand half of the armature the current is passing from back to front, and in those on the left-hand half it is passing from front to back.

Reference to Fig. 26 will then show that the conductors of the right-hand side of the armature will experience a force urging them upwards, while those on the left-hand side are urged downwards. It follows that the armature is caused to rotate, but in the opposite direction to that in which it was driven when being used as a dynamo for the production of current. This would of course necessitate a resetting of the brushes, which have the wrong slope for the running of the machine as a motor.

The case described above is an example of the general rule, that every dynamo, when supplied with current, will run as a motor, and the direction of running when used as a motor is the reverse of that when used as a dynamo, unless of course the electrical connections are altered in any way.

An electromotor, like a dynamo, may be separately excited, series wound, shunt wound, or compound wound. For driving machinery the winding is usually shunt or compound, while for traction it is usually series wound.

One problem that arises in connection with the use of electric motors is particularly worthy of note. The conducting wires of the armature are of fairly low electrical resistance, so that on switching on the current from the supply mains, a very great current will flow. This is not altogether a disadvantage, for the starting of the motor, especially when under load, requires a large current ; but if this large current persisted for long, the heating of the conductors through which it flows would be so great that the insulation would be burnt, and the machine would be permanently injured. Fortunately, however, there is a wonderful compensation at work, for as the speed of the motor increases, the current it takes from the mains becomes less. This at first sight seems surprising, but it is clear that when the armature is rotating, its conductors are cutting across the magnet field produced by the field magnets. This, as we have already seen, is the condition for an electromotive force to be produced in these

conductors, so that as the speed increases this electromotive force rises. By tracing out the connections in Fig. 23, and applying the rule for the direction of induced electromotive force (p. 32), it will be seen that this electromotive force acts in opposition to that in the mains which produces the driving current. This might even be deduced on general grounds, without taking the trouble to trace the various currents and forces; for if the electromotive force tended to increase the driving current, the machine would, when once started, drive itself. Hence perpetual motion would result, and useful energy would be derived from nowhere, which is contrary to experience. This back electromotive force then, limits the current taken by the motor, and the final speed is reached when the current has fallen so that just that power required to turn the armature under the given load, and provide for certain unavoidable losses, is drawn from the mains.

Nevertheless, to prevent excessive current before the motor has picked up speed, starting resistances, or rheostats,

are employed with large motors. These starting resistances are merely wires of moderate resistance in the form of coils which can be cut out step by step as the speed of the armature increases. On attaining full speed, the last of the coil is cut out, the back e.m.f. produced by rotation being then sufficient to prevent the flow of a destructively large current. A simple form of starting resistance

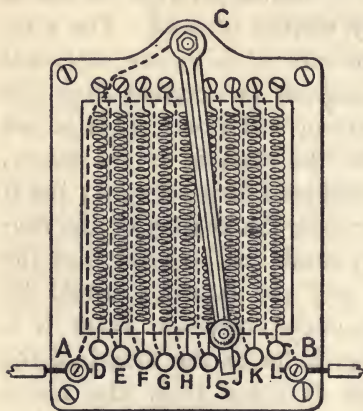

FIG. 27.—Rheostat.

is shown in Fig. 27. In this case there are nine coils of wire stretched upon an iron frame and insulated from it. They are connected up as shown, and it will be seen that the

current entering by the terminal A passes to the arm at C, and thence by the sliding contact S to one or other of the studs D, E, F, G, H, I, J, K, L, and out at B. If the switch is moved so that the current passes to the contact stud D, all the coils must be traversed by the current in passing to L. But if the switch is moved over, a stud at a time, the resistances are cut out one by one, until, with the switch at L, the current passes straight across from C and B, so missing all the resistances. If such an apparatus is placed in series with the armature of a motor, the switch would be at D to begin with, and the nine resistances all being in the circuit, the current would then not be excessive. As the motor picks up speed, the back electromotive force increases, and the switch may then be moved over, step by step, until the contact stud L is reached. When the resistance is entirely removed, the back e.m.f. corresponding to full speed of the motor is attained, and the current has at no time reached an unsafe value. Starting resistances for motors are not generally as simple as the one described, although their principle is exactly the same. They are generally provided with safety devices, so that, should the field current fail, the motor is automatically switched off the mains, or if the load becomes too great, a similar operation is effected, so that injury to the motor due to over-heating is avoided.

A typical electromotor is seen in Fig. 28 (Plate II). It is a 15 h.p. series motor used for driving a machine in the Woolwich Arsenal. The method of gearing to the required amount so that the speed of driving shall be reduced from that of the motor to that required by the machine can be seen.

One of the most ingenious applications of the converse functions of the electric dynamo and motor is now employed very extensively on electric tramways and railways. This consists in making the motors which drive the tram or train also act as brakes for stopping. It has been seen that the same arrangement of field magnet, armature, and commutator will act as a dynamo and convert mechanical

energy into energy of electric current when the armature is made to rotate by mechanical means, or conversely will act as a motor and convert energy of electric current into mechanical energy when an electromotive force to maintain the current is applied to it. If all the inevitable losses due to friction, heating, etc., could be totalled up and allowed for, it is a fundamental principle, that the amount of energy supplied in one form is converted to the other form. Now when the tram is in motion it possesses mechanical energy, and in order to stop the tram this energy must be got rid of. One method occurs when the tram runs up an incline, and the energy of motion does work against the weight of the tram and is so used up. Another way is to apply friction brakes, so that the mechanical energy is converted into heat. But the most refined and delicately applied method is to convert the motors into dynamos and let the tram use up its mechanical energy in driving these dynamos. All that is necessary is to disconnect the motors from the electric mains, and join their terminals together by a conductor, when they immediately act as dynamos, the energy required to drive them coming from the tram, which gradually comes to rest. In the local circuits, large currents may be produced while the speed is great, so that it may be necessary to introduce resistances to prevent this excessive current, with its destructive overheating. These resistances may be cut out step by step as the speed is reduced, so that they act in a similar but converse manner to the starting resistances of a motor. In this case the mechanical energy of the car eventually becomes heat in the armature and resistances in which the current is flowing, whereas with the friction brake the mechanical energy is directly converted into heat. The motor-dynamo or electro-magnetic brake can be very gently or very fiercely applied, according to the amount of resistance placed in the motor circuit, and it is also independent of any greasy surfaces except, of course, where the wheel touches the rail. But there is one thing it will not do,

which is to hold the tram at rest on an incline; for it is only when the tram is moving that there is any braking action. Consequently a friction brake must always be provided as an auxiliary to the electro-magnetic brake.

The controller used for an electric tram or train is of a complicated form, for it has not only to apply and cut off the motor current and put in and out the suitable resistances, but it has also to make various groupings of the motors. This last function renders the use of auxiliary resistance much more restricted than it would be if single motors connected directly across the electric supply mains

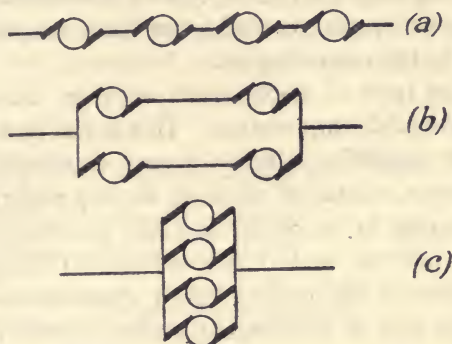

FIG. 29.—Traction. Arrangement of motors for starting.

were used. Suppose that four motors are used to drive the car. If these motors are all placed in **series** so that the same current flows through them all in turn (Fig. 29 (a)), the current at the start will only be one-quarter of what it would be if one motor alone were placed across the mains. The starting current will therefore be limited to a safe amount by the resistances of the four motors in series. Now, on attaining the greatest speed of the car which this series arrangement will give, the controller changes the electrical connections to that of Fig. 29 (b). There is a jump up in current because only two motors are now in series, the full electromotive force being applied to the two pairs. When the speed has risen to its new limit, the

controller again alters the connections to the arrangement (c), in which each motor experiences the full electromotive force of the supply. No injury is experienced from excessive current because the speed reached is such that the back electromotive force prevents an unsafe current from flowing. The motors in Fig. 29 (c) are said to be in parallel, because the current divides, part flowing through each, the separate currents uniting again where they leave the motors. This parallel arrangement is distinctive from the series arrangement of Fig. 29 (a), where the same identical current flows through all the motors.

There is a very important type of electromotor which is driven by alternating currents, but the description of this is deferred to the next chapter.

One other type of electromotor must be mentioned, as it is of considerable importance. This is the motor used as a meter for measuring electric power supplied to a consumer. Power, or rate of working in any circuit, depends upon the current in the circuit and the electromotive force driving the current, and is proportional to both of these. If one ampere is maintained by an electromotive force of one volt, the rate of working, or power, is called the **watt**. It follows that the power which is being expended in any circuit may be measured in watts, where—

$$\text{watts} = \text{amperes} \times \text{volts.}$$

In order to measure the watts expended in any circuit it is sometimes convenient to measure the current by means of an ammeter, and the electromotive force by mean of a voltmeter and to multiply the two values together. An instrument which would do the multiplying for us so that the watts could be read directly would obviously be of great convenience. Such an instrument is called a **wattmeter**, and since its principle is used in the construction of motor power meters, its principle will be explained briefly. An electric current produces a magnetic field, and a second current situated in this field experiences

a force, as was seen on p. 40. The magnetic field of the first current may be magnified by the use of iron cores and pole pieces, as in the case of the electromotor; but even if these are absent the force will still be excited, although it is not so great. Thus one current exerts a force upon another, and it may be found by following the various rules, that currents in the same direction attract each other, while on the other hand currents in opposite directions repel each other. This is made use of in various forms of watt-meter, the Kelvin type shown diagrammatically in Fig. 30 being one of the most satisfactory. If the power in the lamp L is to be measured, the current through it is taken also through four fixed coils A, B, C, and D. The two coils E and F are connected to the lamp terminals, and the

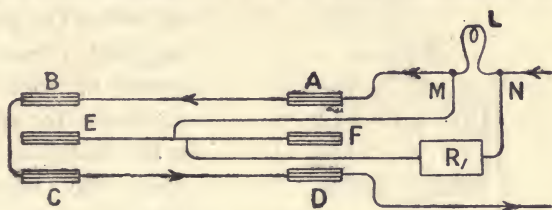

FIG. 30.—Kelvin watt-meter.

current in them is therefore proportional to the electromotive force which drives the current through the lamp. Now E and C, A and F are wound so that the currents all flow in the same direction, and attractions between the coils result, while B and D are in the opposite direction, so that B pushes E downwards and D pushes F upwards. E and F are carried on a balance arm pivoted midway between them, so that the balance is tilted on account of the forces between the coils. The balance is restored to its original position by a weight which can be moved in manner similar to that on a common steel-yard, and the movement of this weight measures the force between the coils. These forces are each proportional to the current in L and to the electromotive force driving this current, and therefore to the watts being expended in L. The scale of the balance

is therefore marked in divisions corresponding to watts, and the instrument thus forms a convenient watt-meter or watt-balance.

The rotation of the arm of the watt-meter being prevented by the balancing weight, continuous rotation is impossible. If, however, the moving coils were designed for continuous rotation, as in the case of the electric motor, and provided with a commutator, the fixed coils would act as field coils, and the driving effect is proportional to the watts used in the circuit. If, further, the motor is arranged so that its speed is proportional to the driving force, the total number of revolutions made by the armature will be

proportional to the watts and to the time for which the power is supplied. Since the power of 1000 watts continued for an hour is the Board of Trade unit, the kilo-watt-hour, the meter may be so provided with indicators that the kilo-watt-hours supplied will be read directly.

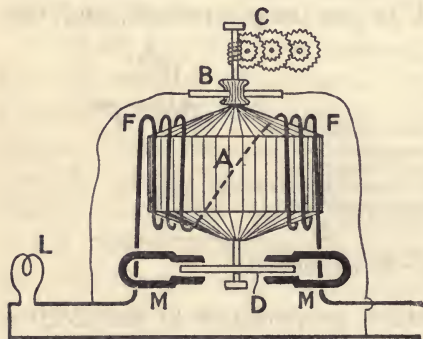

FIG. 31.—Electromotor type of power meter.

There are many designs of electric motor meter, but the principle of them all is shown in Fig. 31. The current through the load, represented by the lamp L, passes through the field coils FF, and the armature A is connected, through the commutator and brushes B, to the two ends of the load circuit, and plays the part of the movable coils of the watt-meter. It follows that the driving force is proportional to the watts to be measured. The speed of the motor is made proportional to the driving force by means of the electro-magnetic brake. A copper disc D mounted on the motor axle, moves in the magnetic field of two permanent magnets MM, and these tend to check the motion (see p.

68), the speed being rendered proportional to the driving force. It is only necessary to add a revolution counter C which consists of a number of dials with pointers, driven by the motor axle. The scales are added and indicate the numbers of kilo-watt-hours used in tenths, units, tens, hundreds, etc.

CHAPTER V

ALTERNATING CURRENTS

THE growth of the use of electric power for industrial purposes is necessarily intimately connected with the question of cost. It is hardly likely that the distribution of power by means of continuous current could ever become economical, because the use of small dynamos, supplying current to a limited area, is extravagant. The difficulty is not got over by building large dynamos to supply considerable areas, for with increasing distance to which the current is to be conveyed, the cost of the copper mains required to carry it runs up with great rapidity, and becomes such a large proportion of the whole cost of the undertaking that the use of continuous current is severely limited.

By continuous or direct current is meant an electric current which flows always in one direction, in distinction to a current which flows alternately backwards and forwards through the conductor. If we refer again to Fig. 23 (p. 35), and pick upon any two of the armature conductors which are diametrically opposite each other, we see that in the one which is descending, the induced current is from back to front, while in the other one, which is ascending, the induced current is from front to back. Consider these two conductors to be the sides of a loop of wire, completed by joining them together at the ends. The conductor which is descending experiences an electromotive force from back to front, and as the two change positions every half-revolution we see that in a loop of wire rotating

in a magnetic field is developed an electromotive force which alternately acts round the coil in the two directions. For half a rotation it acts one way round the coil, and for the next half-rotation it acts the opposite way round. Such a one is called an **alternating electromotive force**, and if the ends of the wire are applied to an external conductor, an **alternating current** will flow in it (also see Fig. 38). In public supply, the number of alternations, or complete cycles of change per second, varies from 25 to 100, but the frequency most commonly employed is 50 cycles per second.

In order to transmit electrical power economically over great distances, the conductors must be made of high-conductivity copper, and must be of such a thickness that the heat produced in them, which of course means wasted power, is as small as possible. Since the heat produced per second in a given conductor is proportional to the square of the current, it follows that the cost of copper required to avoid this loss also varies as the square of the current. Thus, if we imagine the current in a given case to be trebled, the conductor carrying it must be made of nine times the area of cross section, in order to keep the waste due to heating to the same amount as before. This consideration, together with the allowance to be made as the distance of transmission increases, shows us that any method which will keep down the current, while transmitting equal power, must of course be economical. Now

$$\text{power} = \text{current} \times \text{electromotive force},$$

so that by using a high electromotive force, the current can be reduced, while transmitting the same power. As an example, consider the case of a dynamo supplying 1000 amperes at 100 volts; the power is $1000 \times 100 = 100,000$ watts. But if the current were reduced to 100 amperes and the electromotive force increased to 1000 volts the power would still be 100,000 watts, but the current has been reduced to $\frac{1}{10}$ of its original value, so that the copper mains

may be reduced to $\frac{1}{100}$ of their original weight for the same amount of power as before to be wasted in heating the mains. If the distance of transmission is, say, 100 miles, the saving in the high voltage arrangement is enormous; but the difficulty arises that 1000 volts is too high for the safety of the users of the current. The risk from shock and from leakage is considerable at 1000 volts; in fact, the Board of Trade will not allow 250 volts to be exceeded. There is still the possibility of employing separate motors and dynamos locally, the motors taking current at 1000 volts and being coupled to dynamos which produce current at 100 volts. The use of substations of this kind partially solves the difficulty, but it must be borne in mind that such motors and dynamos require constant attention, the cost of which must be set off against the saving of copper in the mains.

It was to solve this problem that the **alternating-current transformer** was developed. From the time of Faraday and Henry the possibility of producing a varying current from another varying current was recognized, but the use of the alternating current was not perfected for many years. The early attempts had no such definite object in view as the distribution of electric power, but were merely devices for getting momentarily very high electromotive forces from a supply of low electromotive force, such as a few galvanic cells. In this case the apparatus is called an **induction coil**, but as it is the prototype of the alternate-current transformer, it is as well to consider it first.

Referring to Fig. 20, p. 31, it was seen that on passing a magnet into a solenoidal coil, an electromotive force is produced in the coil. Again, in Fig. 8, p. 19, it is seen that a current flowing in a solenoid is to all intents and purposes a magnet. Combining these two facts, it follows that if the magnet of Fig. 20 be replaced by a solenoid A (Fig. 32) in which a current is flowing, the effect on the galvanometer G connected to the solenoid B will be the same as before. That is, on pushing A into B, there is a

momentary current in B and G in one direction, and on withdrawing A there is a momentary current in B and G in the opposite direction. A further advance can now be made by keeping the coil A inside the coil B, and starting the current in A by completing its circuit. The momentary current in B and G is exactly the same as that produced by introducing A when its current was flowing. Also, on stopping the current in A by breaking its circuit, there is a momentary current in B and G exactly like that produced by withdrawing A. Thus it does not matter how the current in A is produced and withdrawn, the effect is exactly the same whatever the method. Since the momentary currents are really produced by the magnetic fields being introduced and withdrawn, it follows that anything which increases the magnetic field will increase the effect. This may be

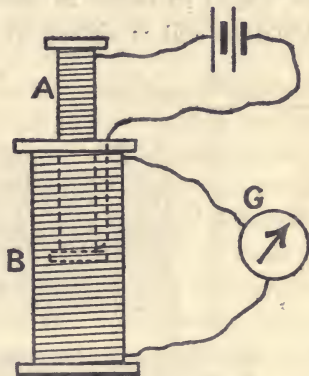

FIG. 32.—Experiment to illustrate the inductive effect of one circuit upon another.

shown by using a stronger current in A, but more effectively by introducing an iron rod or core lying along the axis of the two coils. If, in addition, B consists of many windings, the galvanometer G may be dispensed with, and the wires held in the hand, when a shock will be felt on starting or stopping the current in A ; or if the ends of the circuit B are near to each other, the electromotive force produced in B when the current in A is interrupted may be sufficiently great to cause the current to jump the air-gap, producing a spark. The coil A, in which the current from the battery flows, is called the **primary coil**, and B, the coil in which the induced electromotive force is produced, is called the **secondary coil**. It is of interest to note that the original experiment of Faraday, by which he

discovered the occurrence of induced currents, was of this type. Two coils of wire were wound on an iron ring, and Faraday found that on starting or stopping a current in one of the circuits, a galvanometer in the other circuit indicated a momentary current.

Although modern induction coils differ much in design from the simple apparatus of Fig. 32, yet there is no essential difference between them, but certain accessories are added in order to obtain more efficient working. An induction coil is shown in section in Fig. 33, in which the

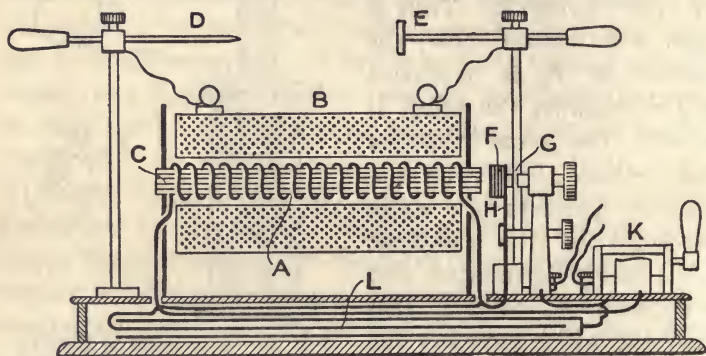

FIG. 33.—Induction coil showing the electric circuits.

primary coil A and the secondary coil B will be easily recognized. The primary coil consists of a few layers of thick wire wound upon the iron core C, which is a bundle of soft-iron wires. Owing to the fact that the induction coil is intended to produce enormously high electromotive force, the secondary coil has a very great number of turns; since the magnetic field produced in the iron core by the primary current cuts every turn of the secondary coil during the process of magnetization, and again in the opposite sense when the iron core is demagnetized. Sparking terminals D and E are connected to the ends of the secondary coil, and between these terminals a spark in air may occur whenever the electromotive force produced in the secondary coil has a sufficiently high value.

In the largest induction coils, the secondary coil is made by winding as much as 100 to 200 miles of fine wire over the primary coil. The method of making and breaking the primary circuit automatically is worthy of note, as the same method is employed in connection with electric bells and buzzers (p. 25). A knob *F* of soft iron, carried by a spring *H*, is attracted by the soft-iron core when this is magnetized. It is therefore pulled forward, and so breaks the contact at *G*, causing interruption of the primary current, with consequent demagnetization of the core. As the attraction between the core and the soft-iron knob ceases, the spring brings the knob back to its old position, and makes contact again at *G*, and the process is then repeated. *K* is a reversing key for changing the direction of the current in the primary coil as required. The only remaining part of the apparatus to describe is the condenser *L*. It consists of layers of tinfoil separated by paper which has been soaked in melted paraffin wax. This condenser is connected across the spark gap *G*. Its function is complicated, but it undoubtedly increases very much the length of spark obtainable from the coil, and also lessens the destruction of the platinum-faced contacts at *G*.

One point in connection with the induction coil is worthy of note: a high electromotive force occurs in the secondary coil in one direction when the primary current starts, and again in the opposite direction when the primary current ceases. It might at first sight be expected that these opposite electromotive forces would be equal in value; but this is not the case, because the primary current dies away much more quickly than it grows. Since the magnetic field therefore collapses much more quickly than it grows, the rate at which the magnetic lines of force cut the secondary coil is much greater on the "break" of the primary circuit than at the "make." The "break" electromotive force is generally sufficiently high for the spark to jump the air gap *DE*, while the "make" electromotive force is insufficient, so that the current in the secondary circuit only

flows in one direction, namely, that corresponding to the break of the primary circuit.

With a moderately large induction coil, an air gap of 20 centimetres may be jumped, and if insulating layers such as sheets of glass be interposed between the secondary terminals they may be pierced by the spark. The crackling noise made by a long spark is characteristic of it, and the appearance closely resembles a flash of lightning on a very small scale, which in fact it is. For producing the high electromotive force required for the production of X-rays and also for the discharge necessary for production of waves for wireless telegraphy, the induction coil has had an extended and important use.

Early attempts to use the induction coil for the production of current for electric lighting resulted in failure, until it was suggested that instead of using batteries and an automatic interrupter for the production and breaking of the primary current, an alternating current should be employed. Many difficulties had to be surmounted, but in the year 1883 several partially successful attempts were made to distribute electric current by this means. The most successful attempt up to then was made in 1885, when the lighting at the Inventions Exhibition at South Kensington was carried out in this way. Alternating current at 1000 volts was led to transformers, where it was converted to current at 100 volts, and so led to the electric lamps. There is no essential difference between an induction coil and an alternating-current transformer, although the names have by usage become applied to different classes of apparatus. The induction coil is used for production of very high electromotive force by repeatedly interrupting a direct current from a few cells as in the apparatus shown in Fig. 33; but when an alternating current flows in the primary circuit, and produces an alternating electromotive force in the secondary circuit, which may be higher or lower than that in the primary circuit, the name **transformer** is applied. If the voltage is raised, the apparatus is

called a **step-up transformer**, if lowered, it is a **step-down transformer**.

For a proper understanding of the mode of action of an alternating-current transformer consider Fig. 34, in which the primary current is supposed to be plotted in the form of a curve. Thus from A to B the current is increasing, and from B to C it is diminishing, reaching zero at C. From C to D it is growing in the reverse direction to the former, and from D to E it is diminishing again to zero. After this the values are repeated for the next cycle, and so on. The magnetic field in the iron core very nearly corresponds at each instant to the primary current, so that from A to B

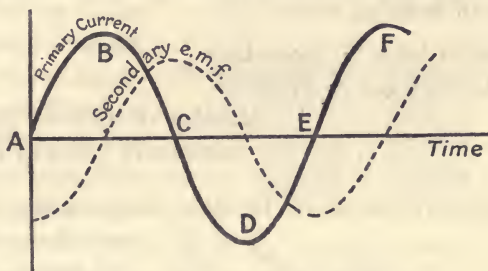

FIG. 34.—Current and e.m.f. curves.

it is increasing, and is therefore cutting the secondary circuit, and produces an electromotive force in it. At B the magnet field has, for an instant, ceased to change, and the secondary electromotive force is zero. The dotted curve shows the electromotive force in the secondary circuit, which, of course, is zero at B, D, etc., and is greatest at A, C, E, etc., where the magnetic field is changing most rapidly. It is in one direction from B to D, in the opposite from D to F. Consequently, if the circuit of the secondary coil be completed through an external conductor, such as a set of incandescent lamps, an alternating current will flow in this circuit. When a secondary current flows, this complicates the determination of the magnetization of the iron core, but the above simple consideration shows how alternating currents may be produced in the secondary circuit.

The electromotive force produced in the secondary coil of the transformer depends upon the amount of magnetization of the core, and also upon the number of turns in the secondary coil. With a great many turns, which in consequence of its length and the smallness of its diameter, will have considerable resistance, a high electromotive force and small current will be available. But with few turns of thick wire, a small electromotive force and large current will be obtained. Thus, by choosing the number of turns in the two coils, a step-up or a step-down transformer may be produced. As a general rule the following relation is nearly true, although, of course, it cannot apply under all conditions of working :—

$$\frac{\text{Electromotive force in Secondary}}{\text{Electromotive force in Primary}} = \frac{\text{Number of turns in Secondary}}{\text{Number of turns in Primary}}$$

Transformers are made in many designs, two of which

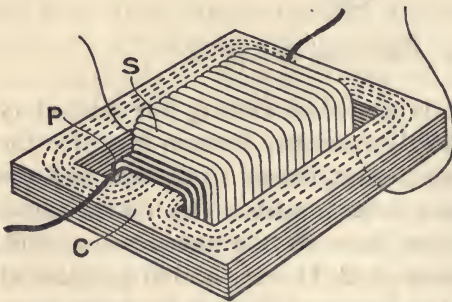

FIG. 35.—Simple transformer for alternating currents.

are shown in Figs. 35 and 36. Fig. 35 is a diagram of a transformer, showing the iron core built up of laminæ of sheet iron, the thick wire coil P being wound on the core, and the long thin wire coil S outside D. This is

known as a closed-core transformer because the magnetic lines of force lie entirely in iron (shown by dotted lines), as distinct from the open-core transformer, in which the lines run partly in air. The induction coil is an example of an open-core transformer. When used as a step-up transformer, P is used as the primary coil, the alternating current supplied

being of low voltage, and S is the secondary coil, in which a high voltage is produced. If the supply is at high voltage, S is used as primary coil, and the low-voltage current is taken from the secondary coil P. In Fig. 36 is seen a transformer, such as is used in a substation for electrical supply. The current at the central station is produced at 20,000 volts, and is conveyed by small mains to transformers in local substations, where it is converted by transformers to 200 volts. A number of transformers may be grouped together in the substation, their secondary coils being connected to "bus" bars, from which the consumers' supply is drawn. Owing to

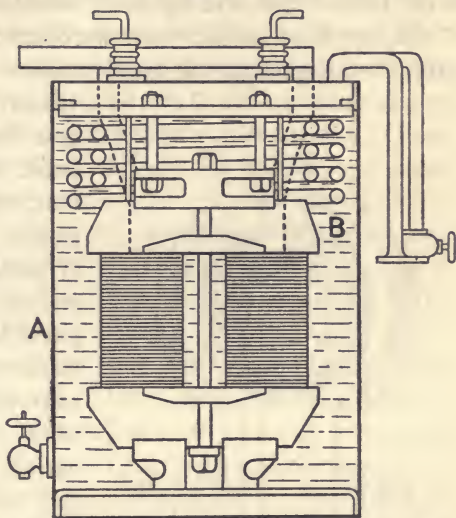

FIG. 36.—Oil-bath transformer for large currents.

the continuous heating which occurs on account of the currents in the primary and secondary coils, and to the reversals of magnetization of the iron core, arrangements for cooling are necessary in large transformers. In Fig. 36 the case A contains oil, which also aids in the insulation, and cold water is circulated in the pipes B, which cause circulation of the oil, and so prevent overheating.

One of the most useful applications of the transformer is seen in the process of electric welding. Very few metals can be welded by the ordinary process of heating, placing the parts to be welded together and hammering while hot. Wrought iron can be treated in this way, but even then the process is tedious, and the welded part is never so strong

as the original metal. In 1886 Prof. Elihu Thomson originated the process of electric welding by placing together the metal parts to be welded, and passing a strong electric current through them, so that it flows across the point of contact. The resistance of the contact being greater than that of the rest of the circuit, most of the heat is produced there, and by using sufficient current, the metal at the two sides of the joint becomes melted, and the two parts fuse together. A small amount of borax is usually

placed on the joint to act as a flux by removing the oxide formed at the high temperature. Even when contact at the molten place is established, the higher resistance of the hotter parts localizes the heating so that melting only occurs near the joint. It is possible to use continuous current for welding, but this requires a specially built dynamo of low armature resistance, to carry the heavy current required. But the alternating current has several advantages over direct current. One form of transformer for welding

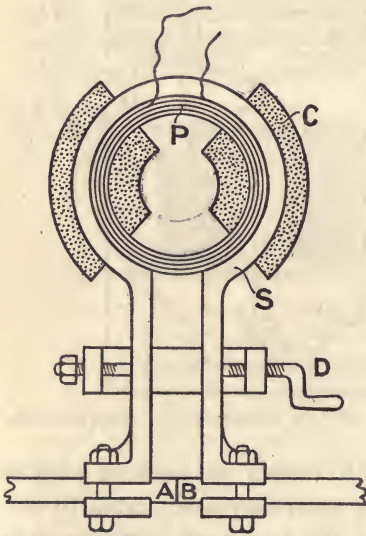

FIG. 37.—Transformer for welding by means of alternating current.

welding, devised by Prof. Elihu Thomson, is illustrated in Fig. 37. The primary coil P has many turns, and is fed with alternating current at moderately high voltage. The secondary S is a stout circle of copper, ending in two clamps, which carry the bars to be welded together. This secondary circuit has a resistance of about 0.0003 ohm, and carries a current of the order of 10,000 amperes. It follows, of course, that the e.m.f. in this secondary circuit

is of the order of one-third of a volt. A switch in the primary circuit enables the current to be applied just for the small time required for the welding. When the surfaces at AB soften, they are pressed together by turning the screw D. The magnetic part of the transformer can hardly be called the core, although it plays a similar part to the ordinary core, because it consists of a quantity of iron wire C wound upon the primary and secondary coils.

It is possible to weld most metals by the electric process; thus cast iron to cast iron, brass to brass, copper to copper, are some of the pairs successfully welded. Even such unlikely pairs as brass to iron, tin to zinc, and silver to platinum have been welded. To weld two pieces of iron rod, each 1 inch in diameter, a current of about 5000 amperes flowing for 20 seconds is necessary. Lengths of steel wire may be welded to form a continuous length, and if the slight enlargement produced at the weld is trimmed off with an emery wheel, the joint can hardly be detected, and is as strong as the rest of the wire. One very interesting application of electric welding is seen in the welding of the links of a chain. It would be thought that the current would pass through the low resistance of the complete part of the link rather than through the join. This, however, is not the case, because the rapidly alternating magnetic field through the complete circuit of the link has the effect of producing electromotive forces which oppose the current, and give this part of the link a high apparent resistance, so that the greater part of the current flows through the join, and effects the welding. This effect may be greatly increased by putting a piece of iron through links at the moment of welding. This increases to a great extent the magnetic effect, with lessening of the current in the complete part of the link.

The development of the alternate-current transformer rendered necessary a corresponding development in the dynamo of the alternating-current form. The modern alternating-current dynamo is developed from the simple

rotating coil. A single rectangular coil of wire, ABCD (Fig. 38), rotating in a magnetic field will have an alternating electromotive force developed in it. The electrical conditions only are shown in the Fig. 38, the mechanical conditions being omitted. One end of the coil, say A, is connected to the brass ring F, mounted on the same axle as the coil, the other end D being connected to E. In the position shown AB is descending, and the electromotive force produced by cutting across the magnetic field is in the direction AB. The electromotive force in CD acts

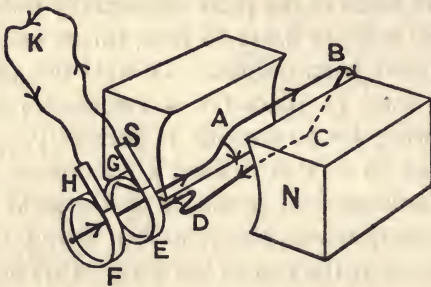

FIG. 38.—Simple alternator. Diagrammatic.

from C to D, so that if the external circuit is complete, a current flows from the brush G to the brush H through this external circuit. During the next half revolution, the current flows in the opposite direction in the external circuit, so that with continuous rotation the external current is alternating, and will be of the type shown in Fig. 34, p. 57. This simple arrangement is of little use in practice, as the rate of rotation of the coil would have to be prohibitively great if a practicable voltage is to be produced. A further consideration shows that the number of cycles of current per second is too small for ordinary use when a single coil is employed. An alternating current flowing in an arc lamp produces the arc twice in each cycle of electromotive force, once with each carbon as positive. Hence the light emitted by the arc lamp fluctuates in intensity, reaching a maximum twice as many times per

second as there are cycles of electromotive force produced by the alternator. The same condition applies to an incandescent lamp, although the fluctuations in luminosity are not so great as in the case of the arc, because the filament has not time to become cold between the successive maxima of current. If the fluctuations in intensity of illumination are less than twenty per second, the effect is very distressing, as the eye perceives the flickering; but with a greater frequency than twenty per second the illumination appears to be continuous, provided that the objects seen are at rest. When the object seen by such illumination is moving, it is more brightly illuminated at successive instants of time than during the intervening periods, so that it is seen in a number of positions instead of appearing to have continuous motion. This effect may be observed very easily by swinging a walking stick when illuminated by alternating-current arc lamps, or even in incandescent lamp illumination, when the stick in several positions will be seen. For these reasons it is necessary that the alternating current should have a frequency of fifty or more cycles per second. The alternating-current generator is therefore provided with a number of coils ranged round a circle in the manner illustrated in Fig. 39. The poles of the field magnet are marked N and S, and are arranged so that N and S poles alternate. With the arrangement shown there are six pairs of poles, but in practice there may be many more. There are twelve armature coils, A, B, C, etc., and these are arranged in series with each other, and with the external circuit R by way of the slip rings and brushes PQ. The armature coils are each represented in the diagram by a single turn. This is only for simplicity, and it will of course be understood that in an actual machine each coil may have many turns. In the position shown it will be seen that the coils A, C, E, G, I, and K, are each approaching a N pole of the field magnet, and there is consequently an electromotive force in the same direction through all these coils. B, D, F, H, J, and L

are at the same instant approaching S poles, so that the electromotive force in them is in the reverse direction with respect to that in A, C, etc. But the coils B, D, etc., are wound in the reverse direction to A, C, etc., with the result that, with respect to the armature circuit, the electromotive forces in all the coils act at any one instant in the same direction. Also the whole electromotive force is reversed as the coils pass from one kind of magnetic pole to the

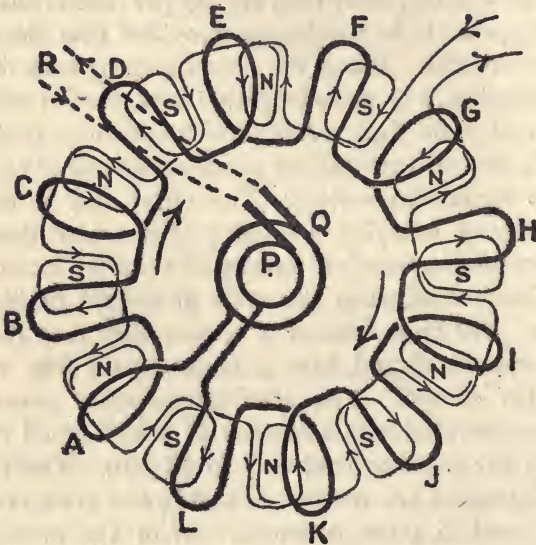

FIG. 39.—Circuits of 12-pole alternator.

other, and the electromotive force of the machine makes a complete cycle while the armature moves through the space of two pole pieces, so that the coil A occupies the position C, and so on. One complete rotation of the armature will therefore correspond to six cycles of electromotive force. In other words, the number of cycles of electromotive force occurring per second is equal to the number of revolutions per second of the armature, multiplied by the number of pairs of poles in the field magnet.

It will have been noticed that the pole pieces retain

their position and polarity throughout. This necessitates a constant current in the windings of the field magnets, which constant current must be supplied by a direct-current dynamo. It follows that an alternator cannot be self-exciting, but requires an auxiliary dynamo for the production of the current for exciting the field magnets. This has one advantage, for it is possible to regulate the strength of the magnetic field by controlling the current by means of a rheostat in the direct-current circuit. In central-station practice the switch-board attendant, on observing a drop in voltage of the alternate-current supply, would increase the field current until the supply is brought back to its normal value.

There is a symmetry about an alternator which is not found in the case of the direct-current dynamo. An examination of Fig. 39 will show that it is immaterial whether the armature rotates and the field magnet is fixed, or whether the armature is fixed and the field magnet rotates. In the latter case the slip rings must be placed in the field magnet circuit. Whichever of the two parts is fixed is usually called the **stator**, and the moving part is called the **rotor**.

The alternator and the alternating-current transformer have between them enabled natural sources of energy to be tapped which would otherwise have continued to run to waste. Among such sources are the waterfalls and rivers, where a large quantity of water falls through a considerable difference in level. Conspicuously amongst these are the Niagara Falls, the rivers of Norway, of Switzerland, and of New Zealand. Alternators driven by water turbines produce alternating current at very high voltage. This may be as high as 200,000 volts, and necessitates great precautions in carrying the current across distances of country amounting to hundreds of miles. The insulation of the cables, which are usually carried overhead on special pillars, is a matter of considerable difficulty, and presents many awkward problems to the electrical engineer. The discharge which

takes place into the atmosphere at such high voltages is the cause, in many cases, of considerable loss of energy, but the saving in the cost of mains, which would be necessary to carry the larger current at lower voltage, and the fact that the actual energy is supplied by nature, render many such schemes practicable.

An account of alternating currents must contain some description of the alternating-current motor. This has been deferred from the chapter on motors on account of the necessity of acquiring first some knowledge of alternating currents. It was seen on p. 41 that every dynamo may be run as a motor if, instead of turning the armature by mechanical means, electric current is supplied to it. This is equally true in the case of the alternating-current dynamo or alternator. It does not follow, however, that such a form of motor is of much use; in fact, the alternating current must resemble the current produced by the machine, not only in having the correct voltage, but it must be in the correct phase at every instant. On examining Fig. 39, it will be seen that, for electrical purposes, each pair of poles with a pair of coils is acting like the direct-current dynamo, and it was shown on p. 41 that if current were supplied to such a machine in the direction in which the machine itself produces current, it would run as a motor, but the direction of running is backwards. But in the alternators there is no commutation and the current must be reversed exactly when the coils have moved forward to the next poles. If the timing is not exact, the current in the rotor poles will get out of step with the appropriate stator poles, and the rotor will no longer be driven. Hence the machine used as a motor must be running at exactly the correct speed, or it will no longer be driven by the current supplied. A motor of this kind is called a **synchronous motor**, and it will only run at one speed, namely, that speed at which the alternating current supplied is always in the correct phase. This introduces a difficulty in starting, for it must be run up to speed before the supply

current is switched on. It cannot, therefore, be started without some mechanical means of driving it, and further, any sudden variation in its load will cause a variation in speed which will probably cause it to get out of step and then stop. For these reasons the synchronous motor is no use for supplying power, and is only employed in certain smaller pieces of apparatus where constancy in speed is of the greatest importance.

The induction motor is not open to the same objections as the synchronous motor, as it can be started by the alternating current which is used to drive it, and in some cases even to start under load. An adequate explanation of the induction motor is not a simple matter. Let us consider a very early experiment by Arago (1825). A magnet

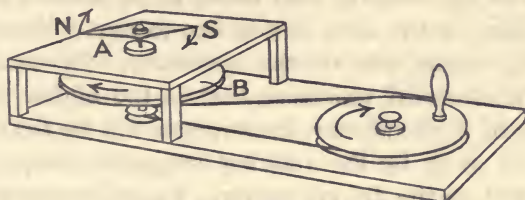

FIG. 40.—Arago's rotation.

A (Fig. 40) is balanced on a needle-point, and in a box underneath it a disc of copper B is caused to rotate. The box protects the magnet from draughts caused by the rotation of the copper disc, but, nevertheless, it is found that the magnet tends to follow the rotation of the disc. If the magnet is a strong one and the disc is massive, it may easily happen that the magnet does actually follow the disc and rotate after it, but it will never rotate as rapidly as the disc. If, instead, the disc were balanced on a needle-point and the magnet caused to rotate, the disc would then follow the rotation of the magnet. Arago was not able to give the explanation of this effect, but in the light of Faraday's discoveries we can see that when the disc rotates it cuts across the magnetic field of the magnet, and therefore electric currents are developed in it. These

currents have a magnetic field, and hence react on the magnet. On general principles it follows that the reaction is always one that endeavours to stop the rotation. It can never assist the rotation, for, if this were the case, once started, the rotation would go on by itself, which is contrary to experience. The reaction between the field of the magnet and the currents produced by rotation will thus tend to reduce the relative motion of the disc and the magnet. But the disc is forcibly driven, and the magnet being pivoted tends, therefore, to follow it. Similarly the disc would follow the magnet if the magnet were driven and the disc pivoted. In general terms we may say that whenever a conductor is situated in a rotating magnetic field, currents are induced in the conductor which by their action with the rotating field make the conductor rotate in the direction of the field, if it is free to turn. We say that a driving couple acts on the conductor. Of course, the lower the electrical resistance, that is, the higher the conductivity of the conductor, the stronger will be the currents developed in it by the rotating magnetic field, and the greater will be the driving power. For this reason copper is the best material to use for the conductor, with the exception, of course, of silver, which is too expensive for general use.

In order to obtain a motor of any practical use, it is necessary to produce a rotating magnetic field of considerable strength. An alternating current will produce an alternating magnetic field; but this is not a rotating field. It may, however, be considered as the resultant of two rotating fields whose directions of rotation are opposite to each other. Consider the following mechanical model consisting of two wheels A and B (Fig. 41), A being mounted on an axle C and provided with a pin E; B mounted on an axle D and provided with a pin F. The pin E slides in a horizontal slot G, and F in the slot H, the two slots G and H being carried by a rod K which travels vertically. If the wheels A and B rotate with equal speeds in opposite

directions, as shown by the arrows, the rod K will be forced to travel up and down at a rate fixed by the speed of rotation of the wheels. Or if the rod be driven up and down with the proper speed it can continue to drive the wheels in opposite directions should they be properly started. In like manner, an alternating magnetic field in one direction, represented by the linear motion of K, may be considered as equivalent to two equal rotating magnetic fields in opposite directions represented by the rotations of the two wheels A and B. Although this equivalence is easy to represent mathematically it is not so easy to represent mechanically, and the rough model will serve to illustrate the general fact that any linear vibration may be considered as equivalent to two equal and opposite circular movements having the same periodic time as the linear vibration. Thus if a mass of metal is placed in a simple alternating magnetic field, such as would be produced by an alternating current flowing in a coil, it may be considered to be acted upon by two rotating magnetic fields at the same time, but with opposite directions of rotation. Of course under these conditions it will not move; it cannot choose between the two directions in which it is being driven. It is as though two copper discs were being driven in opposite directions, one on either side of the magnet in Arago's experiment. But if the mass of metal be *started in one direction*, by any means, it may be shown by either theory or experiment that the force driving it in the direction in which it is started will increase, while the effect of the oppositely rotating component of the magnetic field gets less. The metal therefore gains speed and will be driven

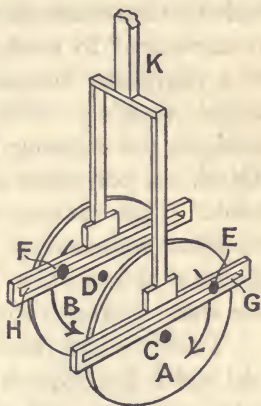

FIG. 41.—Model to illustrate the compounding of two opposite rotations to form a single reciprocating motion.

more and more by the rotating magnetic field in its own direction, while the effect of the opposite magnetic field gets less, so that when running at considerable speed it will be driven by the single alternating magnetic field. This is the principle of the single-phase induction motor. The only difficulty yet remaining is to start the rotation in one direction or the other. This is performed by means of a separate circuit which is cut out when once a sufficient speed of rotation has been attained. Such a machine is called an **induction motor**. The effect of the rotating circuit is equivalent to rendering the ordinary current equivalent to a polyphase current, the magnetic field of which is an actual rotating field. In polyphase alternating-current working the rotating magnetic field is more simply produced, but polyphase currents are beyond the scope of this book. They present one of the most difficult problems in electrical engineering. It is on account of their complexity that the single-phase induction motor as described above has come into such common use.

There is one interesting modification of the induction coil which has acquired great importance of late years, that is the **magneto**, used for causing the spark which fires the explosive mixture of gases in the cylinder of the internal-combustion engine. The most common type of this engine is undoubtedly the petrol motor, in which the explosive mixture of air and petrol vapour is drawn into the cylinder, compressed by the piston and fired by a spark from an induction coil or magneto. The spark necessary for ignition was, in the early types of motor, produced by a small induction coil, the primary current being produced by a battery of a few storage cells. This arrangement is very convenient in many respects, but has the disadvantage of depending upon the storage cells. These cells are liable to destruction, and, what is worse, they may become discharged without giving any sign of their condition, and so give out at the most inconvenient time. Also the mere fact of having to charge these cells periodically is in itself

objectionable. The popularity of the magneto is undoubtedly due to the fact that it is independent of any charging, and is therefore always ready for use. It is driven by the motor itself and is in all respects automatic. With the efficient magnetos now made, the spark given is sufficient for its purpose even at quite low speeds ; but it must be remembered that the motor must be started running, generally by hand, before the magneto will produce any spark.

With the mechanism of the petrol motor we are not

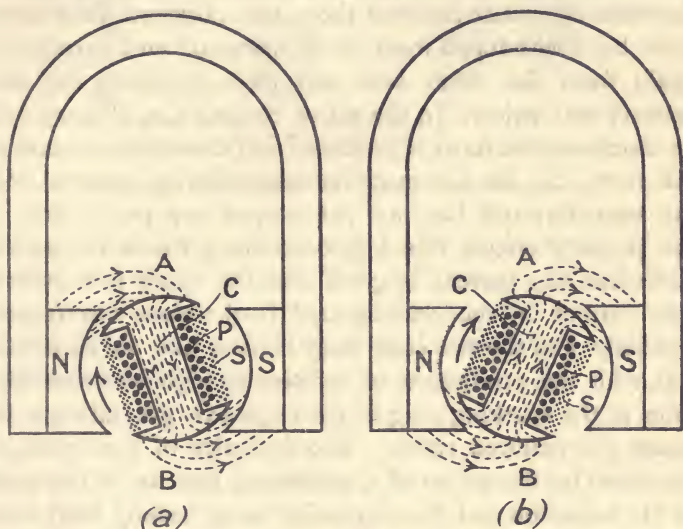

FIG. 42.—Circuits of the magneto.

concerned here, but the principle involved in the magneto may readily be grasped. A permanent magnet having soft-iron pole faces N and S (Fig. 42) produces the requisite magnetic field, in which the armature, shown in section, rotates. The core C consists of sheets of soft iron stamped to the required shape and bolted together. P is a primary coil of stout wire and S a secondary coil, consisting of many turns of fine wire, as in the induction coil. In fact, the magneto is really an induction coil ; but it differs from

the ordinary coil in the manner in which the primary current is produced. Instead of using a battery, the primary current is produced by the rotation of the primary coil in the combined magnetic field of the permanent magnet and the soft-iron core C. It will be seen in Fig. 42 (a) that the magnetic lines of force are passing from the pole N, through the core, to the pole S, and that they enter at the end A of the core and leave at B. By the time the position shown in Fig. 42 (b) is reached, the lines of force are entering at B and leaving at A. It is therefore clear that between these two positions they must have been withdrawn from the primary coil and introduced again from the other end, and have therefore cut the primary coil twice. In the act of cutting the primary coil an electromotive force is produced and considerable current will flow. So far the machine resembles a dynamo, and the secondary coil has not yet played any part. But in the primary circuit is a key or contact, which is opened just when the current is great and the spark is required. The current in the primary coil is therefore interrupted suddenly, and the two coils then behave like an induction coil, with the production of sufficiently high electromotive force at the sparking plug in the explosive gas mixture to cause the required spark. The intensity of the spark is increased by the action of a condenser, just as in the case of the induction coil, the condenser being usually built into one end of the armature and rotating with it. A wire AB, Fig. 43, with a thick covering of insulating material, connects the secondary coil of the magneto to the insulated terminal C of the sparking plug, which is screwed into the cylinder cover. The terminal D is connected to "earth," which in this case is the body of the machine, and is represented for electrical purposes by EE, and supplies the return circuit to the secondary coil of the magneto. Every time the primary circuit of the magneto is broken by the rotating key, the high voltage in the secondary coil produces a spark between D and C, thus firing the explosive

mixture of air and petrol vapour in the cylinder. It would be out of place to describe here the distribution key required when several cylinders are used with a single magneto, or the method of driving the magneto from the

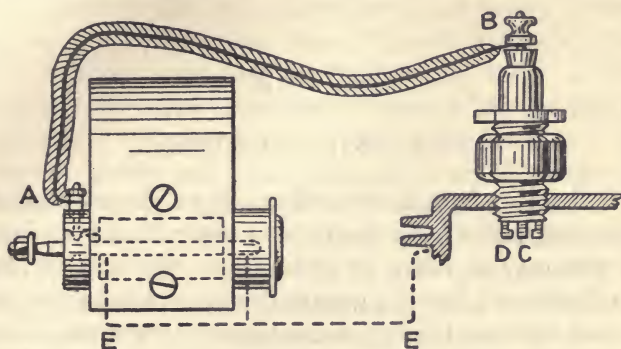

FIG. 43.—Arrangement of magneto and sparking plug.

main shaft. Such details may be found in works on the petrol motor. The induction coil and its special form, the magneto, have rendered possible the great strides made in the design and use of the internal combustion engine in the last two decades.

CHAPTER VI

ELECTRIC LIGHTING

ONE of the earliest known effects of an electric current is the heating effect. By means of a few cells, a fine piece of iron wire may be raised to white heat. The wire will then burn in the air ; but if a material such as platinum be used, the wire becomes brightly incandescent, and if the heating be pushed too far, the wire will fuse. It was natural that as soon as electric current could be produced upon an economical scale, its employment for artificial illumination should be attempted. The early attempts, however, were not very successful, and it was many years before electricity could compete successfully with gas for illuminating purposes. The last twenty years have seen a continual war between the two, sometimes one appearing to lead, and sometimes the other. There is little doubt that where lighting is to be performed on the large scale, as out of doors, the electric arc has established a permanent precedence over gas ; but for indoor lighting the matter is not so certain. The incandescent gas mantle seemed to herald the death of the old carbon filament electric incandescent lamp, but the construction of more and more efficient forms of metal filament lamps has swung the advantage again to the side of electricity. The deciding factor is not as a rule the small relative advantage in economy of one form of illumination over the other, but the convenience in use and the character of the light obtained. The fact that electricity does not involve the using up of the oxygen of the atmosphere, with production of objectionable and destructive

fumes as does gas, gives it a permanent advantage. The further advantage that the current can be "switched on or off" without the necessity of "lighting" lies of course with electricity.

The earliest attempt to construct an electric incandescent lamp was made by sealing a fine platinum wire into a glass bulb. Edison succeeded in constructing such a lamp. The choice of material naturally fell upon platinum, because of its high melting point and electrical resistance. The commoner metals fuse at a temperature much below that at which light is freely radiated, and platinum has the further advantage, that when passing through the fused wall of a glass bulb, the glass will not crack, nor will the joint loosen as the glass cools, because glass and platinum both contract to the same extent on cooling. Even now platinum is the only substance known which fulfils this condition, and the use of substitutes, which has often been attempted, has not been generally successful, so that platinum is still used whenever a wire has to be sealed into glass, as in the case of leads passing into an incandescent lamp. The substance employed for the filament must also be highly ductile, so that the filaments may be made sufficiently fine to localize the heating, which occurs in the current circuit, almost entirely to the filament within the lamp. Also the electrical resistance of the material should be high, so that the filament need not be excessively fine or very long in attaining a convenient resistance for the lamp. On constructing a lamp with a platinum filament, it was found at an early stage that the efficiency was increased greatly by pumping out the air from the bulb. The air exerts a considerable cooling effect upon the filament, and exhausting the bulb therefore increases considerably the efficiency of the lamp, so the process has been continued with later types.

Although platinum has a very high melting point, it is necessary to use it at a temperature so near this, for the economical production of light, that any accidental rise in

the voltage of the supply is apt to destroy the lamp by melting the filament. Edison, in about 1879, turned his attention to carbon as a material for use in incandescent lamps. The chief difficulty with this material is the production of the filament in the correct shape, for carbon is a brittle material, not in the least ductile. But carbon forms the groundwork of all living matter, and many compounds, such as wood and cotton, are compounds of carbon and hydrogen, with a very small amount of other substances. Also wood is very pliable and can be bent into any shape required, and if heated out of contact with air, the hydrogen and other materials are driven off, leaving hard compact carbon in the shape required. In his early carbon lamps, Edison used bamboo filaments carbonized by heating. But this soon gave place to the process which became employed universally. Cellulose, generally in the form of cotton, is dissolved in a solution of zinc chloride, forming a paste or viscous mass. This paste or syrup is pressed through a metal die of suitable diameter and emerges into alcohol, where it soon hardens. It is then wound on to a drum and allowed to dry. Owing to its flexibility, the filament is then cut to suitable lengths and bent to its ultimate shape upon round blocks of carbon, many filaments resting side by side on each block. The blocks are then packed in crucibles along with graphite, and heated to about 2000° C., when the volatile substances being driven off, the properly formed filaments remain.

Since the carbon filament must lie entirely within the bulb of the incandescent lamp, it is necessary to attach some wire or lead to it, which passes through the glass wall. As we have seen, platinum is the most suitable material for this purpose, although from its high price, the wire lead usually consists of platinum only where it actually passes through the glass. The joint on to the carbon is made by laying the wire and carbon in contact in a material such as benzole, which is rich in carbon, and passing an electric

current through them. The heating at the joint is then sufficient to decompose the benzole, and a hard compact mass of carbon is deposited on the joint, making a most efficient seal.

Before placing in the bulb, a process called "flashing" is performed. This consists in raising the filament to incandescence by means of a current, while situated in some hydrocarbon vapour such as benzole. At the temperature of incandescence of the filament, the hydrocarbon vapour is decomposed, carbon being deposited upon the filament. This process has three distinct advantages. The surface of the filament is rendered smooth and suitable for uniform radiation of light, and the deposition can be continued until the thickness of the filament is increased to a suitable amount for the purpose for which the lamp is to be used. Further, the filament at its thinner parts becomes hotter than at the thicker parts, with the result that the carbon is more freely deposited on the thinner parts. This process of flashing therefore renders the filament uniform throughout its length and removes the "patchy" appearance which a carbon filament possesses that has not been subjected to flashing.

After the filament is "flashed" it is sealed by the glass-blower into the bulb, and fixed into its metal cap; the air is exhausted, leaving a fairly good vacuum, and the lamp is then sealed off at the point of connection to the air-pump (Fig. 44). The carbon filament lamp must, of course, be highly exhausted, not only on account of the cooling effect of any air remaining, but because the oxygen of the air would combine with the carbon at the temperature of incandescence, so that the filament would be burnt up instantly.

The problem of illumination involves the question of

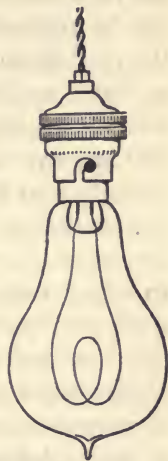

FIG. 44.—Carbon-filament lamp.

the rate of emission of light from hot bodies. At low temperatures the emission does not affect the eye although it produces warmth; it is called radiant heat. If the temperature of a body be raised to about 700° C. the radiation emitted consists of rays which we call red, which produce an effect upon the eye, and we say that the body is at a "dull red heat." At a higher temperature the body becomes "white hot," and in order to give out light of the same character as daylight, that is, light from the sun, the temperature of the body would require to be about 6000° C. We are never likely to attain by artificial means such a temperature as this, but the higher the temperature that can be attained for the radiating body, the greater will be the proportion of the energy supplied to it which is radiated as light, and the nearer will the character of the light emitted approach to that of daylight. Thus the efficiency will improve with rise of temperature of the filament of the incandescent lamp. A word of warning is necessary here. The radiation referred to here is a pure temperature effect corresponding to what in physics is called a "black" body, to which carbon approximates. It must not be confused with the "selective" radiation which many substances in the gaseous form emit, as for example, the yellow light of incandescent sodium vapour or calcium vapour, the crimson of strontium, or the green of thallium. The employment of such substances to obtain flames of various colours in the arc lamp will be found on p. 89.

The carbon-filament lamp has not a very high efficiency, as it requires about 2.5 to 3.5 watts for every candle-power. The reason is that, on raising the temperature of the lamp above the value for ordinary running, the carbon becomes disintegrated and is deposited as a black film on the inner surface of the glass bulb, and the filament soon breaks. Hence for many years a search was made for some substance of which the filament could be made, which would not melt or disintegrate at temperatures much higher than is allowable for the carbon filament, so that the fraction of

the energy supplied to the lamp, which is radiated in the form of light, should be greater, and of a colour more nearly approaching daylight. Attention was naturally turned towards the rare metals, some of which have exceedingly high melting points.

In order to obtain some idea of the type of material required, it may be noted that on the centigrade scale of temperature, water freezes at 0° and boils at 100° . Lead melts at 327° C., gold at about 1060° C., platinum at 1760° C., osmium 2200° C., tantalum 2900° C., and tungsten 3000° C. approximately, while the temperature of the sun is somewhere near 6000° C. The temperature of the carbon filament of an incandescent lamp is probably in the neighbourhood of 1300° C. The three metals osmium, tantalum, and tungsten have all been employed for the construction of the filaments of incandescent lamps.

The difficulty encountered in the early attempts to construct a metal-filament lamp is that of obtaining a sufficiently thin filament to keep the current from being excessive when the lamp is used on ordinary voltages. Tantalum is ductile and can be drawn into fine wires; but in the early lamps a considerable length of wire had to be used, the wire being looped backwards and forwards upon a supporting framework. Tungsten is an exceedingly useful metal for the construction of filaments, but unlike tantalum it is brittle, and could not be drawn into the form of wire. Successful attempts were made by mixing powdered tungsten with a gummy material and forcing the paste through a fine hole of the required diameter. The filament so formed was wound on its supports and the gummy material driven off on heating the filament by passing an electric current through it. The filament then consisted of fairly pure metal, but required great care in handling owing to its brittleness. The Osram lamps, which played such an important part in displacing carbon lamps from ordinary use in the year 1908, were of this form.

Undoubtedly the greatest achievement in electric

incandescent lighting is the production of the drawn filament of tungsten. Tungsten is soft and easily welded at high temperatures, and on being welded into one mass by hammering, is capable of being drawn into wire of suitable diameter for lamp filaments. In the finished lamp, illustrated in Fig. 45, the filament is

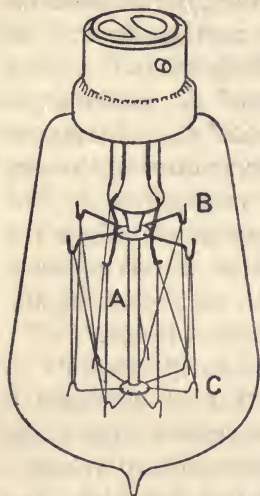

FIG. 45.—Metal-filament lamp.

is seen supported upon two wire spiders B and C carried by a glass stem A. The spiders are sufficiently flexible to maintain the filament tight when expanded by heat, during the time that the lamp is burning, and to bend to allow for the shrinkage of the filament when cold. Such lamps have very good efficiency (about 1 watt per candle-power), and are durable. They should run for 1000 hours without the blackening of the bulb being excessive. Over-running of the lamp, that is, running it at too high a temperature, improves the efficiency but spoils the lamp, owing

to the blackening, as in the case of the carbon-filament lamp.

An interesting device has been employed recently for allowing a higher temperature for the filament to be used than that ordinarily employed. The bulb contains the gas nitrogen, at about half the atmospheric pressure. Nitrogen being inert does not injure the filament, and the gas in contact with the hot filament expands and rises. This upward current of gas carries with it the disintegrated part of the filament, which is deposited in the upper part of the bulb, and so does not obstruct the light emitted. In this way an efficiency of about half a watt per candle-power is obtained; in fact these lamps are called "half-watt" lamps, although the name "gas-filled lamp" is now coming into use.

It has been known from early times that when an electric circuit is broken, a spark occurs at the point of break. This spark is evidence of very high temperature, for the quality of the light emitted shows it to be due to the metal of the conductor in a state of vapour. In most cases the spark is soon quenched, but if the electromotive force driving the current is fairly great, the metallic vapour and the gas at high temperature form a conducting bridge and the current persists. In this case the phenomenon is called the **electric arc**. The first description of an undoubted electric arc, as distinguished from a spark, is due to Sir Humphry Davy in 1812, who, using a battery of 200 large cells, obtained between carbon rods a continuous "arch of light," from which the name "arc" has arisen. When the electric arc occurs between metals they are melted, the gap lengthens rapidly, and the arc is quenched. With carbon, however, there is no melting, and the arc may persist for a long time. With an electromotive force of over 40 volts or thereabout in the circuit, the electric arc between two carbon rods is easily produced. It is thus seen that the useful production of an electric arc depends upon the peculiar properties of the substance carbon. Carbon exists in nature in many forms. It occurs in the transparent crystalline form, and is then called diamond. Also in the form of a hard compact mass, when it is called plumbágo or blacklead, and it is also an essential constituent of all living materials. It is the chief constituent of coal, and if the gaseous portion is driven off by heat, an impure mass of carbon remains, which is called coke. One of the most peculiar properties of carbon is that of becoming volatilized when heated to a very high temperature, without first going through the liquid stage. Most solid substances melt when the temperature is raised sufficiently, and at still higher temperatures volatilize or pass into the form of gas or vapour. But under no conditions that we can produce will carbon liquefy. Consequently, if the electric arc be formed between two rods of carbon, the rods may volatilize

and burn away at the high temperature of the arc, but they will not liquefy. For this reason carbon is always used when it is required to produce an electric arc.

The form of the arc is important, and it may be studied by examining the arc formed between two carbon rods of about one centimetre diameter. Owing to the brightness of the hot carbon rods it is not safe to look at the arc with the naked eye; blackened glass must be used between the arc and the eye. Or an image of the arc may be produced on a white screen by means of a lens, such as a reading glass, which method has several advantages. The image

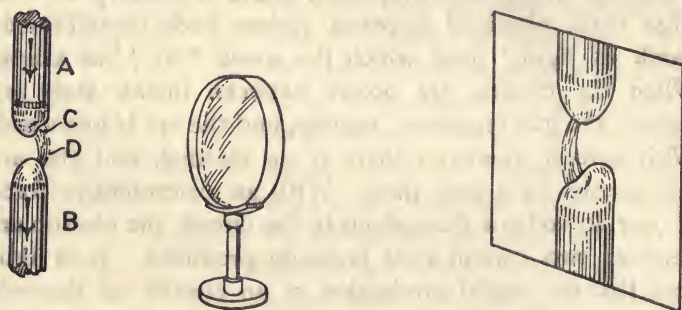

FIG. 46.—Method of examining an electric arc.

is not too bright to be looked at directly; it may be larger than the arc itself, and measurements of the length of the arc may be made upon the screen, which could only with difficulty be made upon the arc itself. The arrangement may be seen in Fig. 46, in which the actual arc is seen at D. In order to start the arc it is necessary that the carbons should be first brought into contact and then separated. Where the carbons touch, the electrical resistance is considerable, and the heat caused by the current in flowing across this place of high resistance is so great that some of the carbon burns and some volatilizes, the hot gases produced forming a conducting bridge, across which the current flows from carbon to carbon as the two are separated. This process is called "striking the arc." The rudimentary

explanation of it given here is imperfect in many ways. For example, it is known that hot bodies emit charges of negative electricity called electrons (see Chapter XI), and that these play a large part in carrying the current across the gap. But we must be content here with a description of the phenomenon without too strict inquiry into its mechanism.

On examining the arc it will be seen that it forms a pale blue band of gas D (Fig. 46) of curved form, from one carbon to the other. From this curved form the name "arc" is derived. The luminosity of the arc itself is only small, but the ends of the carbon rods, between which the arc is formed, are very hot, and give out a considerable amount of light. One spot is the brightest of all, and from it most of the light is emitted. This spot is situated upon the carbon by which the current enters, which is called the **positive carbon**. Owing to the high temperature of this spot, from which the arc springs, the carbon wears away more rapidly there than elsewhere, so that a cup or crater is formed. Whatever may be the shape of the end of the carbon before the arc is struck, it soon wears down to a slightly conical form, ending in the crater C (Fig. 46). The negative carbon B does not present any crater, and soon acquires a nearly conical form, owing to the burning of the carbon rod at its edges. The crater is the source of most of the light given out by the electric arc, only a comparatively small amount being given out by the actual arc and by the negative carbon. This limitation of the brightly luminous area has one disadvantage, which is, that the other parts of the carbons, particularly the negative carbon, are apt to obstruct the light from it. For this reason, when the light is required for projection purposes, or in the case of a searchlight, the carbons are tilted, as in Fig. 47, to allow a free passage for the light in the direction required. There is also one great advantage in the luminosity being confined to the crater, for it gives what is very nearly a point source of light. This is of considerable importance in

the case of a projection lantern, as it is only by using a small source of light that a brilliant, uniformly illuminated image can be produced. In practice it is found that the bright spot wanders about the carbon, giving rise to disturbing fluctuations in the light emitted in any given direction. In order to obviate this difficulty the positive

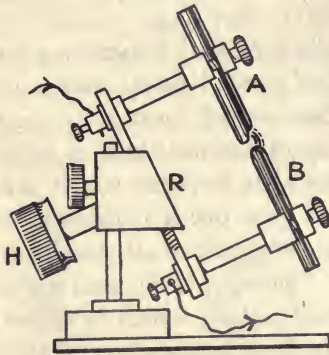

FIG. 47.—Hand-feed arc lamp for projection lantern.

carbon is made with a core of carbon softer than the remainder. The softer carbon volatilizes easily, and the arc then springs only from the edge of the core, so that its wandering is limited in extent. Cored carbons burn away more rapidly than solid carbons, so that it is usual to use cored carbons for the positives and solid carbons for the negatives.

Also the positive carbons, owing to the high temperature of the crater, burn away more rapidly than the negative carbons, and are for this reason usually made of larger diameter.

The amount of light given out by the arc depends upon the size of the bright spot or crater, and this in turn depends upon the current. With an increase in current the crater does not become hotter, but increases in size. It has been estimated by Violle that with carbon the temperature of the crater is about 3500° centigrade.

It must be remembered that the light emitted by the crater may not all be usefully employed, as much of it may be obstructed by the negative carbon.

It was suggested by Sir William Abney that the temperature of the crater is the volatilization temperature of carbon. This would explain the constancy of the luminosity per unit area of the crater. Many workers have helped to elucidate the phenomena exhibited by the electric

arc, but the name of Mrs. Ayrton deserves particular mention. To her is due the explanation of the hissing of the arc when the current is too great and the arc too short. The crater is then too large to occupy the end only of the carbon and extends up the side. The air can then reach the crater and the carbon burns, instead of merely volatilizing, and in this case the well-known hissing sound is produced. The connection between area of crater, current, and candle-power is important. Forrest found that each square millimetre of the crater emits an amount of light corresponding to 172 to 174 candle-power, and it has been shown recently by Mr. N. A. Allen that the current is directly proportional to the area of crater, being 0.746 ampere per square millimeter. This gives a candle-power of 232 per ampere.

With an alternating current supply, the direction of the current is reversed so rapidly that no crater is formed; the two carbons form nearly flat surfaces opposite to each other, and the efficiency of the arc as a light producer is lessened by the obstruction of the light by the carbons themselves.

From the moment of the discovery of the electric arc, it was obvious that the great brilliance of the crater would provide a convenient means of producing light by means of the electric current. However, it was not until 1876 that the first serious attempt was made to use the arc for lighting, the reason being that the economical production of electric current took many years to develop. In that year Jablochkoff employed two parallel carbon rods, separated by an insulating material. The arc between the tips of the rods being started, the carbons gradually burn away, the insulating material being dissipated at the same time. These were called Jablochkoff's candles. They soon gave place to more convenient arc lamps.

Arc lamps may be run from electric mains at any voltage, provided that the 40 volts required for the arc itself is exceeded. With mains at a higher voltage, some resistance must be placed in series with the arc; in fact,

some such resistance must always be used because the arc by itself is unstable: the current tends to increase rapidly or decrease rapidly, since the resistance of the arc gets less with increasing current and gets greater with decreasing current, thus necessitating the use of a steadying resistance in series with the arc.

For use with a projection lantern, the simple hand-feeding arrangement shown in Fig. 47 is highly efficient. By means of the handle H and the racks and pinion R the carbons A and B may be approached to each other until they touch. The operator then separates them, thus striking the arc. The length of the arc for proper running can then be adjusted from time to time. But for running in inaccessible places and for public lighting it is necessary to provide some automatic feeding mechanism for the carbons. As the carbons burn away, the arc gets too long, and the current drops. On the other hand, if the arc is too short, as on striking, the current is too great. This variation in current is usually employed to make the necessary adjustment in the position of the carbons for proper running. Many forms of mechanism have been devised for regulating the length of the arc automatically, but most of them depend upon the fact that an iron cylinder, situated partly inside a solenoid, or long coil, carrying an electric current, is pulled into the solenoid with a force which depends upon the strength of the current. The principle of this method is illustrated in Fig. 48. The current, entering by the terminal A, passes through the solenoid B consisting of thick wire, since it carries the whole current of the arc, which may be 20 to 30 amperes. The iron plunger C fits loosely into the solenoid, and at its base carries the holder D of the positive carbon. The current passes from the solenoid through the arc, and out by way of the negative carbon carrier E and the terminal F. Before the current passes, the weight of the iron plunger and the positive carbon ensures that the carbons shall be in contact. On switching on the current, the pull of the

solenoid on the iron plunger raises the positive carbon from contact with the negative carbon, and thus the arc is struck. As the carbons separate, either on striking the arc, or on the burning away of the carbons, the electrical resistance of the arc increases so that the current drops. This, of course, decreases the pull of the solenoid on the iron plunger, which allows the positive carbon to drop slightly, so shortening the arc. For a given arrangement of solenoid and plunger, the arc will only be steady for a given current, and its length is automatically adjusted until this length is attained. An additional coil G is seen in Fig. 48, which is made of a considerable length of fine wire, placed in parallel with the arc. When the resistance of the arc increases, the current in G drops, and when the resistance of the arc falls, the current in G increases. Since it is wound in the opposite direction to the main coil B, and is oppositely affected by the arc, the result is that it helps the main coil in maintaining the adjustment of the length of the arc.

Such a simple arrangement as that just described would not be found very suitable in practice, as the motion of the carbons would be jerky and the regulation would not be sufficiently delicate. The principle, however, is applied in the form of the automatic arc lamp of which there are many patterns. It is usual to balance, to some extent, the weight of the moving carbon with its holder, and provide some form of ratchet and pawl for moving the arc forward by small steps as the carbons burn away.

Considerable advantage is gained by enclosing the arc in a glass bulb or globe which is made very nearly

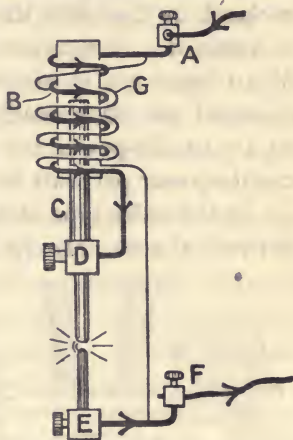

FIG. 48.—Principle of the automatic-feed arc lamp.

airtight. When the arc is running, the air, or rather the oxygen of the air, in the globe is soon used up in forming carbon dioxide (CO_2), the product of combustion of the carbon in air. When the oxygen in the globe is all used up, no further combustion of the carbon can take place. Also a much greater length of arc may be used with this enclosed arc than with the open type, and a higher efficiency is attained. A common value for the illuminating power of an open arc is about 1000 candle-power, and for an enclosed arc 2000 candle-power, with an efficiency of 1.5 to 2.0 candle-power per watt for the former, and 3 to 4 candle-power per watt for the latter.

In the older type of arc lamp the useful illumination is derived almost entirely from the crater, and this, as we

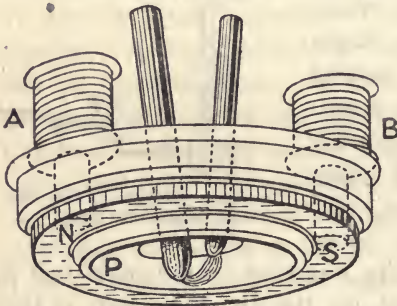

FIG. 49.—Carbone and flame arc lamp.

have seen, is liable to be hidden by the negative carbon. The increase in length of the arc obtained in the enclosed type leads to a greater efficiency, because of the smaller obstruction due to the negative carbon; but a further increase in efficiency was obtained by Mr. Carbone by using a very long arc and placing the carbons so that there is no obstruction of light by the negative carbon. The two carbons are inclined at a small angle to each other, and the arc takes place at their lower ends, as will be seen in Fig. 49. It is well known that an arc produced at the lower end of a pair of carbons will tend to be carried up them by the hot-gas currents produced. This effect would be deleterious in the present case, and the device of using a magnetic field to spread out the arc in a downwards direction is employed. The current flowing through the arc also flows through two coils A and B, and so magnetizes

the iron ring whose poles are at N and S. The magnetic field due to this ring is at right angles to the direction of the arc itself, and therefore will exert a force upon the arc, as was seen on p. 40, urging it downwards. Another device consists of a white porcelain reflector P, called the **economizer**, which not only reflects the light downwards but serves to protect the mechanism of the lamp from the hot gases arising from the arc. It has also the effect of enclosing the arc partially, for the burnt gases are caught by it, and so by protecting the arc from the air, increases the life of the carbons and assists in their burning away at equal rates.

The "Carbone" lamp prepared the way for the modern **flame arc**, which possesses all the characteristics of the "Carbone" lamp, even to the horizontal magnetic field and the porcelain economizer, but presents the new feature of rendering the arc itself brightly luminous, so that the light emitted is no longer entirely due to the positive crater. The flame arc proper may be said to date from the time of the work of Bremer on the addition of certain fluorides to the carbons, to give the arc a high luminosity due to the emission of light by certain materials at very high temperature. Thus many metallic vapours when raised to a very high temperature emit light of a particular colour; the golden yellow of the sodium flame is very well known, as well as the crimson flame of strontium. In the construction of flame arc carbons, strontium fluoride is used for the red arc, cerium fluoride for a white arc, but for the most common of all, the familiar yellow flame arc, calcium fluoride is used. The fluoride is powdered and mixed with finely ground carbon and made into a paste with a solution of potassium silicate, this paste is pressed into a circular hole running the whole length of the carbon, which is made in the ordinary way; that is, finely ground gas retort carbon is mixed with soot and tar and pressed through dies and baked at high temperature.

The core containing the fluoride may have various sizes

and compositions dictated by experience, but it is not found that any great advantage accrues from having both carbons impregnated. It is sufficient if the positive carbon alone possess a core containing the fluoride, the core of the negative being the soft core such as is used with the ordinary arc.

One other feature of the flame arc should be noticed. Owing to the desirability of having long and thin carbons, their electrical resistance is considerable, and would vary very much as the carbons burn away. Hence a second hole is made in the carbon, down which a brass wire passes, the wire being bent over at the upper end, serving to make good electrical contact with the holder. This wire carries most of the current, and reduces the electrical resistance; it volatilizes or burns away at the temperature of the arc.

Yellow flame arcs present the most efficient form of electric lighting at the present time. Although their colour renders them objectionable for indoors, yet in open spaces their characteristic colour has a cheery effect, and their economy is easily seen from the fact that the various makes of lamps have efficiencies varying from 3 to 10 candle-power per watt.

CHAPTER VII

THE ELECTRIC TELEGRAPH

FROM the very early years of the nineteenth century many people were attracted by the idea of using electricity for the conveyance of messages. The earliest attempt consisted in discharging a Leyden jar into an insulated wire at the sending station, which caused the divergence of a pair of suspended pith balls at the receiving station. Considerable ingenuity was expended upon devising a system of signals, but such methods break down on account of the very high insulation required for the wire or line and the signalling apparatus. The leak of electricity from the line is so great that the system is useless over any but the smallest distances. Electric telegraphy only became practicable after the discovery of Oersted, that an electric current is accompanied by a magnet field, and the later discovery that the magnetic field could be intensified by winding the wire carrying the current into the form of a coil. The use of the electric telegraph gave a great impetus to the study of the electric current, and was for many years the only branch of electrical work which had any commercial application. Much of the work of Wheatstone and of Kelvin, which was afterwards found to be applicable to other branches of electricity, arose through their study of the problems connected with telegraphy. In 1839 Cooke and Wheatstone devised a system by which the letters of the alphabet could be telegraphed from one place to another, and the printing telegraph of Hughes came at a later date. On account of its rapidity in working and

simplicity of apparatus, the simple circuit using a key and battery at one end of the line and some form of galvanometer or indicator at the other end came into general use. A current of short duration, corresponding to a **dot**, and one of longer period corresponding to a **dash**, can, by combining them into suitable arrangements, be made to indicate every letter of the alphabet, together with the numerals and certain special signs for stops and official instructions. The system now generally employed is the Morse code, which is here given.

—	a	— — — —	j	— — —	s
— — — —	b	— — — —	k	— — —	t
— — — —	c	— — — —	l	— — — —	u
— — — —	d	— — — —	m	— — — —	v
—	e	— — — —	n	— — — —	w
— — — —	f	— — — —	o	— — — —	x
— — — —	g	— — — —	p	— — — —	y
— — — —	h	— — — —	q	— — — —	z
— —	i	— — — —	r		

FIG. 50.—Morse code.

The simplest form of apparatus necessary for using the Morse code of signalling is merely a key K (Fig. 51) and battery B at one station, and some form of galvanometer or

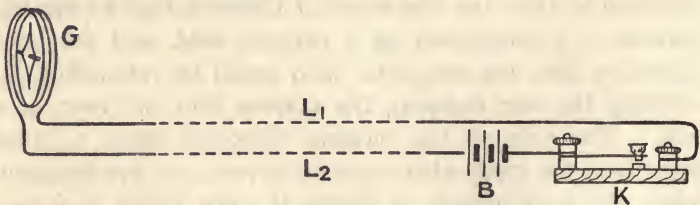

FIG. 51.—Simple electric telegraph.

indicator G at the other, the two stations being connected by a pair of insulating conducting lines L_1 , L_2 . One of these lines may be dispensed with if the conductors are properly earthed at each station, so that the current which flows from one station to the other through a line or cable returns through the ground or, in the case of a submarine cable, through the sea. The proper earthing of the line is

important; it is not sufficient to put the line in contact with the ground, but it must be connected to plates buried several feet deep in moist earth. On depressing the key K for a short or a long time the needle of the galvanometer is deflected for a corresponding interval, and the dots and dashes of the Morse code may be so conveyed. The simple arrangement of apparatus shown in Fig. 51 would, of course, only enable signals to be sent in one direction. In practice the apparatus must be duplicated, for transmission in both directions.

There is not a great variety in the type of key or of battery used for ordinary telegraphy; but there are several

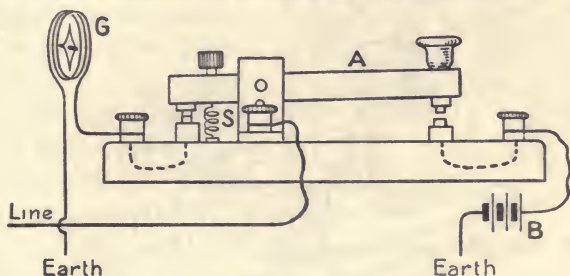

FIG. 52.—Morse key used for sending.

distinct forms of receiving instrument. In Fig. 52 is illustrated an ordinary Morse key. It will be seen that on depressing the knob at the end of the brass arm A, the battery B is connected through the key to the line, and a current is caused to flow in the receiving instrument at the distant station. On releasing the key, the spring S raises A and disconnects the battery from the line. It also causes contact at the back stop, which brings the receiving instrument into circuit for the reception of signals, so that only one line to connect the two stations is necessary.

Of the receiving instruments, the form most commonly used in the post office telegraphic service is the sounder, one pattern of which is illustrated in Fig. 53. The current from the line passes through the two coils A and B of an electro-magnet which attracts the piece of soft iron CD,

and so pulls down the brass arm EF of the lever, causing the stop G to strike the metal pillar, thus producing a sound or click. When the current ceases, a spring causes the lever to spring back, and in so doing another click is caused when it strikes the stop H. The interval between the clicks marks the duration of the current, and therefore corresponds to a dot or a dash of the Morse code. In the case of the Morse inker a strip of paper is caused to travel by clock-work and passes under the lever, which in this case carries an inked wheel, so that the dots and dashes are marked upon the paper as it travels. This method has the advantage over reading by sound, that the message can be

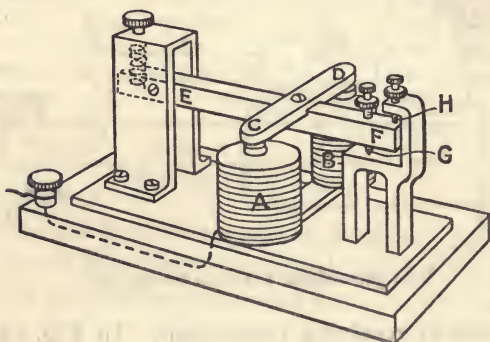

FIG. 53.—Sounder for receiving.

checked by the operator without the necessity of resending it. If the currents in the line are feeble, an arrangement similar in principle to the sounder, and called a **relay** may be used, the function of which is to close a local circuit containing a battery and sounder or printing machine. The local battery may then be made sufficiently strong to work the mechanism of the printer.

For railway telegraphic work it is more usual to employ a detector having a permanent magnet, so that currents in opposite directions will cause opposite deflections. A current in one direction will then deflect the north pole of the magnet to the left (Fig. 54) and the pointer P attached to the

magnet will strike the left-hand stop A, which indicates a dot. Or, if the current is in the reverse direction, a deflection in the opposite direction is caused and the pointer strikes the stop B, indicating a dash. If two bells having different sounds are used for A and B the dots and dashes may be recognized by the operator by ear, and the necessity of watching the instrument is avoided.

When extremely feeble currents only are to be detected, as in transmission over long submarine cables, a much more sensitive indicator than either of the two last described must be used. Lord Kelvin, then Prof. W. Thomson, devised such an instrument especially for use with the trans-Atlantic

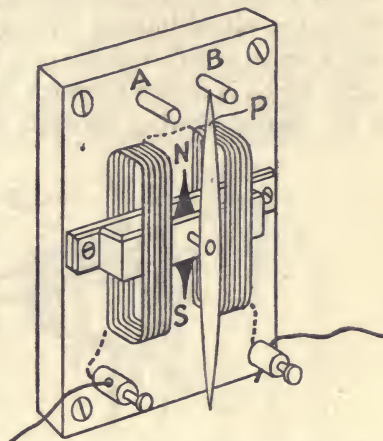

FIG. 54.—Railway telegraphic receiver.

cable. It is really a very delicate galvanometer, with a special form of inker, which he called a *siphon recorder*. Special interest attaches to the siphon recorder, as it is the first case in which the galvanometer consisted of a coil suspended in a permanent magnetic field. It gave rise to a type of galvanometer which is now used almost universally, and is known as the *suspended coil galvanometer*, to distinguish it from the older form in which the coil that carries the current is fixed, a very light magnet being suspended at its centre. Since in the siphon recorder the magnet is fixed, very powerful magnetic fields can be employed, but, of course, the coil, being suspended, must now be made very light, so that the suspension may not hinder its motion. This, however, is no disadvantage when only feeble currents are to be observed. The current from the line L (Fig. 55) passes by means of flexible wires to the suspended coil

ABCD of many turns which hangs in the field of a powerful magnet NS. If the current flows down AD and up CB it follows from the rule on p. 40, that AD is driven outwards from the support and BC inwards. Since A and B are attached by fine silk threads to the rocker EF, this is tilted by the motion of the coil. The rocker EF carries the actual tube or siphon GHK, the end G dipping into a vessel of ink and the end K resting against a strip of paper which is driven forwards by clockwork. When there is no current flowing through the coil, K is at rest, and

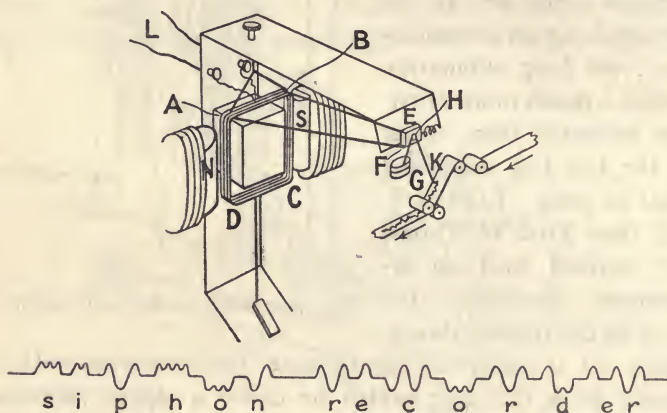

FIG. 55.—Kelvin siphon recorder.

leaves a straight line track of ink upon the moving paper. But a current in one direction in the coil causes a deviation of the ink line to one side, and a current in the opposite direction causes a deviation to the other side. One side corresponds to a dot and the other to a dash, so that the Morse code may be used. The appearance of a record is shown in the lower part of Fig. 55.

As the electric telegraph became more familiar to the public the demand for its use increased until the telegraph lines laid were unable to transmit all the messages required. The ingenuity of telegraphic workers was therefore directed to the problem of increasing the utility of each line. This

has been attained in two ways, first, by devising arrangements by means of which two or more messages may be transmitted over a line at one and the same time, and second, by increasing the actual rate of transmission of the message far beyond that which can be acquired by a human operator. Under the first heading there are many systems, known respectively as duplex, quadruplex, or multiplex systems, according to whether two, four, or more messages can be sent simultaneously over one line. Of the duplex type there are two common systems, one known as the differential

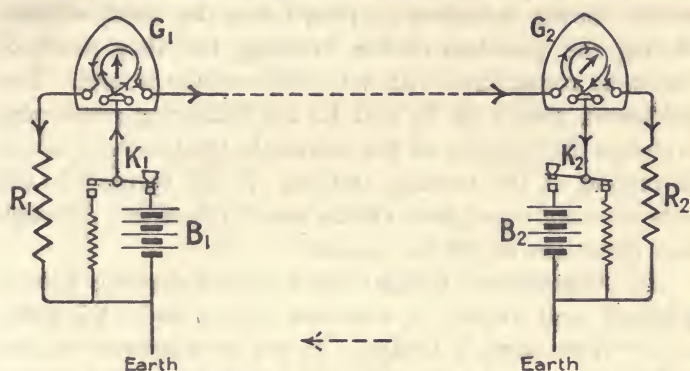

FIG. 56.—Differential duplex telegraph.

system, which is generally used on land lines, and the other the **Wheatstone's bridge system**, which is used in connection with submarine cables. The differential duplex system is illustrated in Fig. 56, in which the two instruments G₁ and G₂ are of the galvanometer type shown in Fig. 54. But in this case the coil of each galvanometer is wound in two parts, the two parts being exactly alike. If, then, the current flows the same way through the two halves of the coil, the effects will be added, and the needle will be deflected by the magnetic effects of the two halves. If, on the other hand, the current flows in opposite directions round the two halves, their effects on the needle are in opposition and will cancel each other, so that the current will not affect the needle. In Fig. 56 it will be seen that the Morse key K₁

is depressed so that the battery B_1 sends a current through the two coils of G_1 in opposite directions, and therefore this current does not disturb the needle of G_1 . But the current to the line passes round both coils of G_2 in the same direction, with the result that the needle of G_2 is deflected. Hence the depressing of K_1 affects the galvanometer G_2 , but not G_1 ; and similarly the depressing of K_2 affects the galvanometer G_1 only. It follows that messages can be sent in both directions along the line at the same time without causing any confusion. In place of the galvanometers shown, sounders or relays may be used, without altering the principle of the working, but they must, of course, be constructed with coils differentially wound. The resistances shown at R_1 and R_2 are balancing resistances to ensure the equality of the current in the two coils of the instrument at the sending station. If the currents in the coils were not equal, their effects would not cancel, although their directions might be opposite.

The **Wheatstone's bridge** duplex system depends upon a principle, well known in electrical testing under the name of the Wheatstone's bridge. In the arrangement shown in Fig. 57, the current from the battery B_1 enters the system of resistances at A, and then divides, one part going through R_1 , L and the distant station to earth, and the other going through R_2 and R_4 to earth. Now in such a system, if we let R_3 represent the combined resistance of the line and the distant station, the principle of the Wheatstone's bridge states that no current will flow through the galvanometer G_1 when the four resistances R_1 , R_2 , R_3 , and R_4 form a simple proportion; that is, when $\frac{R_1}{R_2} = \frac{R_3}{R_4}$. It follows, then, that if R_1 and R_2 are equal, and R_4 is adjusted to be equal to R_3 , this proportion is fulfilled, and although the current is flowing to the distant station, none flows through the galvanometer G_1 . At the distant station the current arriving at B will divide, part going through the galvanometer G_2 , so that this galvanometer always indicates a

current when the key K_1 is depressed. Similarly, on proper adjustment of the resistances being made, the depression of the key K_2 will affect the galvanometer G_1 , but will not affect G_2 . It is therefore seen that the messages going in opposite directions are independent of each other, and duplex working has been attained.

A further extension of usefulness of the line is obtained by using two kinds of key and two kinds of relay at each station. One key merely reverses the current in the line, and these reversals only affect one of the relays, since the other relay is not sensitive to reversals of small currents. The other key switches in more cells, and therefore in-

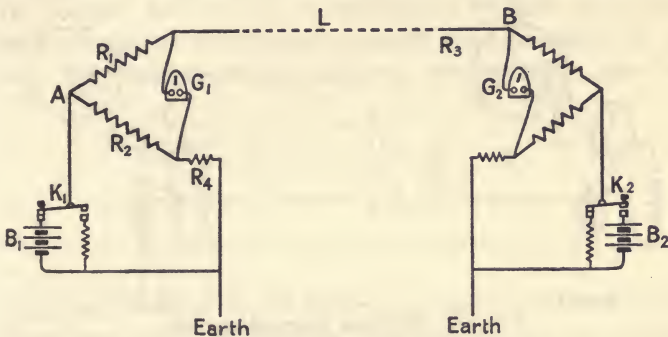

FIG. 57.—Wheatstone's bridge duplex telegraph.

creases the current in the line, and so affects the second relay only, which is only sensitive to change in strength of the current. Thus two messages may be sent along one line in the same direction at the same time without interfering with each other. This is called **duplex working**. Since each of the arrangements may be applied along with a duplex arrangement, either differential or bridge, it follows that the line may be used to transmit four messages at the same time, two in either direction. Such an arrangement is said to be **quadruplex**.

Still further advantage may be taken of a single telegraph line by employing a **multiplex system**. This necessitates the use of two motors which are driven at

exactly the same speed, one being situated at each station. Each motor drives an arm which travels over a disc divided into conducting sectors, insulated from each other. A transmitting instrument at the sending station is connected to the sector, which is joined to the line at the same instant as the corresponding receiving instrument at the distant station is joined to the line through its sector.

Thus, if the two conducting arms A and B are driven at the same speed, the instruments connected to each sector, say No. 2, as shown in Fig. 58, will be connected together once in each revolution of the arms. Four other sets of instruments may be connected to other sectors, so that five

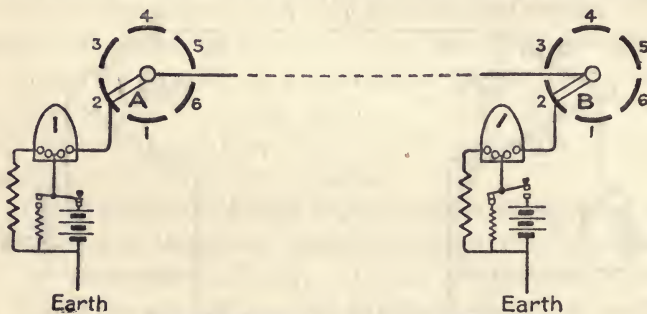

FIG. 58.—Multiplex telegraphic system.

sets are in use simultaneously. The currents between each set of instruments will, of course, be intermittent, since each set is using the line for less than one-sixth of the time of revolution of the conducting arm. But if the number of contacts per second is great enough, and the receiving instruments are somewhat sluggish in their movement, the intermittance of the current is not noticed. This may be effected, either by driving the arms at considerable speed, or by dividing the disc into more than six sectors, say 24 or 36, so that each circuit uses the line four or six times per revolution. Both methods are employed in practice. The arms may be driven by clockwork or by electric motors, but in either case they must be regulated to run at exactly the same speed. This synchronizing is effected by using one of the

sectors at each station for sending a current which accelerates or retards an electric controlling device, according as it arrives just after or just before the time corresponding to exact running. Thus, if the rotating arm at either station lags slightly, the impulse causes it to be accelerated, and if it should be running slightly too fast the impulse retards it. It is clear that the utmost importance attaches to the running of the arms at the same speed at the two stations, and any minute variation in speed must be corrected immediately.

It has already been mentioned (p. 97) that there is a second method of increasing the usefulness of a telegraph line, namely, by devising a mechanical method of sending the intermittent or reversed currents corresponding to the dots and dashes of the code of letters. The speed of

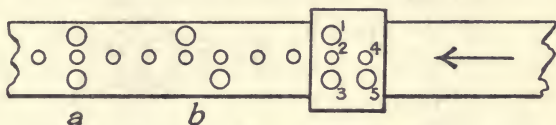

FIG. 59.—Ribbon of Wheatstone automatic telegraph.

signalling by hand is not usually greater than about thirty words per minute, so that the time required for transmitting a message consisting of several thousands of words in this way would be considerable. It is therefore usual to divide the message into sections, and several operators are working at the same time, each operator being engaged in transferring his section of the message to paper slips, which can afterwards be run through the transmitting apparatus, which can send the message at the rate of several hundred words per minute. Such a method is known as that of **automatic working**, one of the earliest and most successful being performed by the Wheatstone automatic transmitter. The message is transferred to a slip of paper by punching holes in it according to a definite system. Five steel punches, 1, 2, 3, 4, 5, are arranged to punch holes in a strip of paper as shown (Fig. 59), and three levers are arranged

so that if one of them is depressed; punches 1, 2, 3, and 4 perforate the paper, corresponding to a dot as at *a*. The second lever depresses 1, 2, 4, and 5, and perforates the paper as shown at *b*, this corresponding to a dash. The third lever punches 2 and 4 only, which are the spacing holes, by means of which the paper strip will be driven through the transmitter. The principle of the Wheatstone transmitter is illustrated in Fig. 60. The paper strip *A*, upon which the message has been punched, is driven forwards by means of a spur-wheel *B*, and the two thin rods or needles *C* and *D* are kept in vertical motion by the

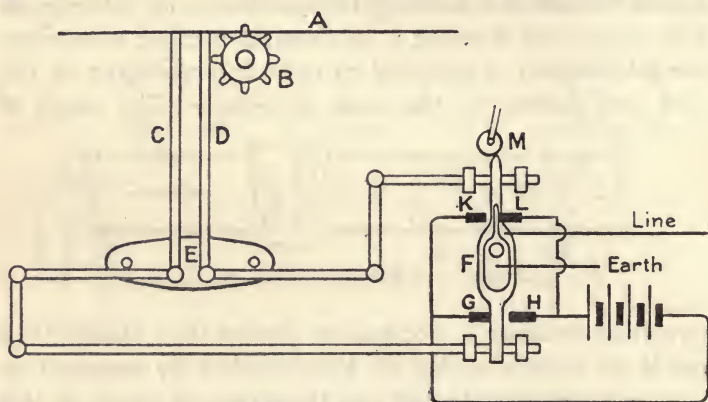

FIG. 60.—Wheatstone automatic transmitter.

rocker *E*. The extent of their motion is limited by the paper strip, because they are arranged to come opposite the upper and lower rows of holes respectively in the strips. If, for example, *D* on travelling upwards passes through a hole in the strip, the lever *F* is pushed over, making contact at *G*, and a current is sent to the line, while the positive end of the battery is connected to earth through *L*. The rod *C* is placed half a space between the middle holes, later than *D*, so that if on being driven upwards it finds a hole in the lower row (Fig. 59) corresponding to a dot, it passes through, and the travel of the lever pushes *F* over, so that contact is made at *H* and *K*, and a reverse current

is sent to the line. If, however, a dash were being transmitted, the needle C would not encounter a hole in the strip until after a longer interval, so C could not travel upwards and reverse the current in the line until a greater time had elapsed, and a dash would be indicated at the distant station. The double key enables reversals of current to be employed instead of a simple make and break, the stops K and L causing the earthing of that end of the battery which is not put to the line. The jockey wheel M ensures a firm pressure of the lever against the stops, and holds the lever in position until a reverse impulse is received.

One of the earliest telegraphic systems was that of Hughes, in which the letters of the alphabet were telegraphed directly. A wheel around which the letters are arranged is situated at each station. At the sending station the wheel is turned until the required letter is uppermost, which process sends a succession of currents to the line by means of stops, one stop corresponding to each letter. Thus for A one impulse is sent, for D four, for H eight, and so on. At the receiving station, an electromagnet moves the wheel forward one space for each current impulse, so that it brings the letter to the top corresponding to the letter at the sending station. This system is slow in working and soon gave place to the more rapid Morse system, but it is a sample of the kind of sending which might be adapted to print the message, for it would be easy to arrange type round the wheel instead of depending upon visual reading.

Of late years rapid systems for printing have been devised, which enable far greater use to be made of a line than could be attained even by the multiplex systems, for the message is printed automatically, without the necessity of reading by the operator. One of the most efficient and rapid systems is that of D. Murray, in which a machine resembling a typewriter punches a tape at the sending station and another prints the message on a sheet or page at the receiving station. The speed of the printer is about

900 letters or 200 words a minute, and with five operators at each end, on the Murray system, about 200 telegrams an hour can be exchanged. On the Murray system, five spaces are allotted to each letter and the holes are punched in these spaces, each corresponding to a letter. This is a development of the Baudot system, and has the advantage

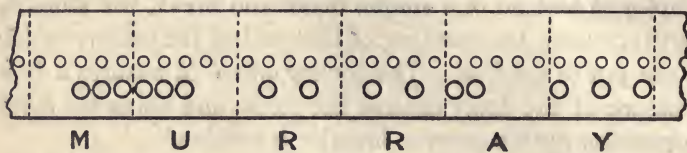

FIG. 61.—Ribbon of Murray automatic printing telegraph.

that every letter occupies the same length of the strip, as shown in Fig. 61. The transmitting apparatus resembles that of Wheatstone, but there is only one lever to pass through the holes in the strip. The star wheel B (Fig. 62) feeds forward the strip A. The needle C is attached to the horizontal thrust lever which has a tooth G on its under

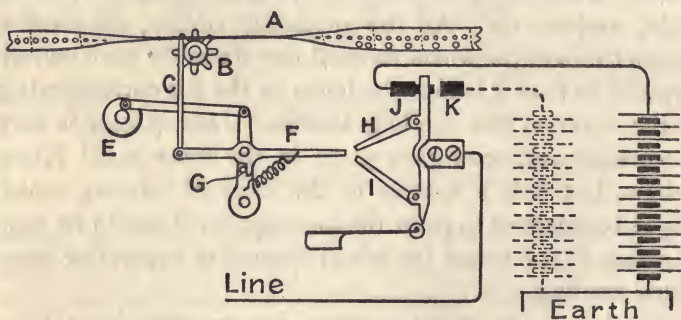

FIG. 62.—Murray automatic transmitter.

side. It is kept oscillating by the cam E, and when C travels upwards through a hole in the strip, the lever F is tilted so that it strikes the arm I and contact is made at J. If in the next oscillation C again passes through a hole, nothing further happens and the current to line continues; but if C should meet an unperforated part of the strip, the lever F is tilted and strikes the arm H, so that contact is

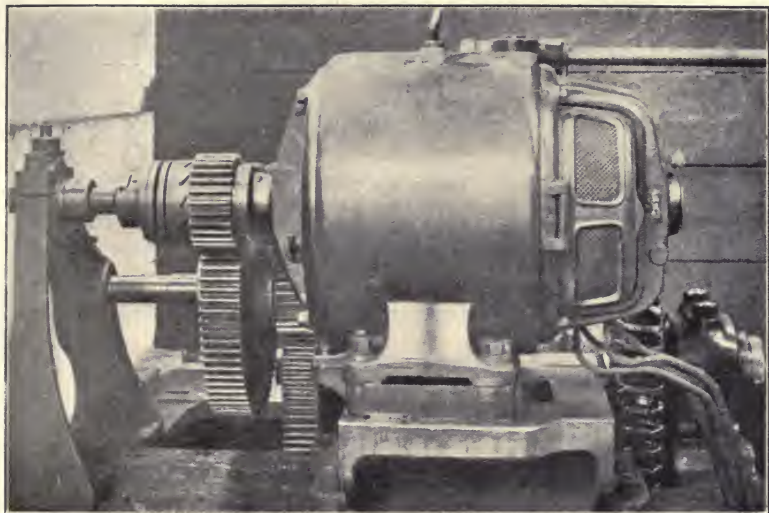

FIG. 28.—15 H.P. series motor with slip coupling to call attention to overload.
[From the "Journal" of the Institution of Electrical Engineers.]

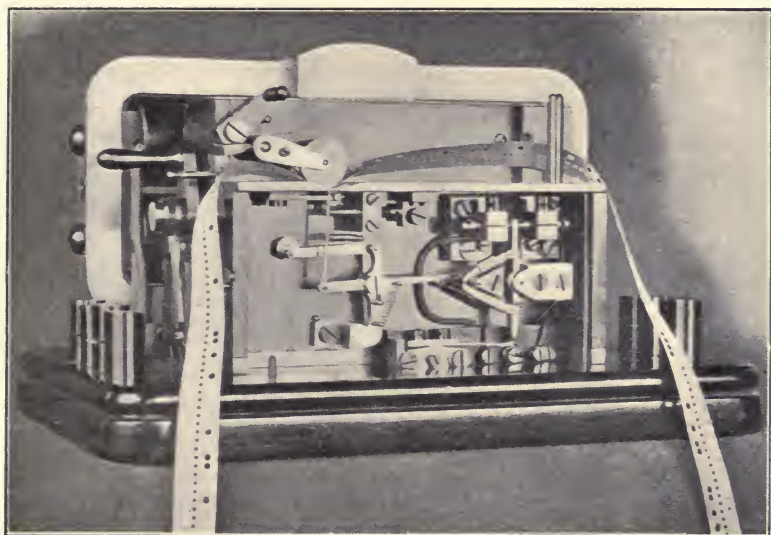

FIG. 64.—Single-line Murray transmitter.
[From the "Journal" of the Institution of Electrical Engineers.]



broken at J and made at K, causing a reversal of the current in the line. The moving parts are driven by a synchronous electromotor whose speed is governed by a vibrating reed very similar to an electrically driven tuning-fork (p. 26). At the receiving end, the current actuates the electro-magnet of a relay which punches holes in a strip, similar to those of the sending strip, and this strip is fed through a typewriter of a particular pattern. The five rods at A are driven all at the same time against the tape, and only those which fall upon holes pass through. Each rod A is attached to a bar cut out in a key-like form, and every combination of holes to form a letter in the strip

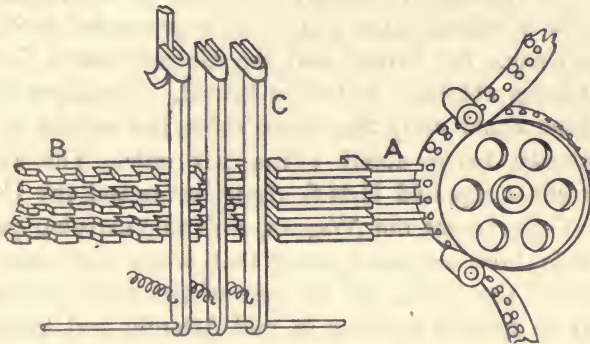

FIG. 63.—Arrangement of keys for Murray telegraph printer.

brings one set of five slots in the bars vertically over each other, so that one of the vertical rods C can pass into these slots. Each rod C actuates one letter of the typewriter, which has the usual arrangement for feeding forward the paper. A general view of the Murray single-line transmitter is seen in Fig. 64 (Plate II). From this short survey it will be understood that the question of telegraphic printing is one of great mechanical complexity, and only the briefest of indications of the principles employed is attempted.

Submarine telegraphy is in these days so overshadowed by wireless telegraphy, that we are apt to lose sight of its

importance and of the tremendous impetus which its first successful development gave, not only to commerce, but to the science of electricity. It is perhaps impossible to close this chapter in a better way than by giving some account of the difficulties encountered and overcome in establishing the first long-distance submarine telegraphic communication, namely that across the Atlantic Ocean. The early discoveries soon led to the erection of land lines of greater and greater length, so that by the middle of the last century the number of telegraphic installations was considerable, and short submarine cables were in successful use, that between Dover and Calais being laid in 1851. In October, 1856, the Atlantic Telegraph Company was formed, and the work of manufacture of the cable proceeded with, concessions from the British and the United States Governments being obtained and ships loaned. No single ship of that time could carry the whole cable, the weight of the one chosen being about 1 ton per mile. The British Government supplied H.M.S. *Agamemnon* and the United States Government the *Niagara*, each ship carrying part of the cable; the intention being that when one ship had completed the laying of its part of the cable, the parts should be spliced together in mid-Atlantic, and the other ship then complete the laying. The shore end was landed from the *Niagara* at Valentia on August 5, 1857, but after 330 nautical miles of cable had been laid the cable broke, owing to a faulty manipulation of the paying-out gear. The expedition was then given up for that year, and the ships returned to England. The second attempt to lay this cable was made in 1858, the same two ships sailing on June 10. On this occasion the plan was for both ships to proceed to mid-Atlantic, splice their two ends of the cable, and then one ship to lay the cable to Valentia, the other to lay its part to Newfoundland. The splice was made on June 26, but after several breaks occurring, both ships returned to Queenstown, leaving again for another attempt on July 17, and effecting the splice on July 29. On

August 5 both ships completed the task, each laying its end of the cable, and at 3.55 p.m. on that day the first current was sent between the two continents.

Although not in charge of the scientific part of the undertaking, Lord Kelvin, then Prof. William Thomson, was its real inspiration and guide. He it was who pointed out the electrical difficulties of signalling through very long submarine cables, and supplied the means of overcoming them. It was pointed out by him that a sharp variation in the value of the current would become blurred as it proceeded along the cable, owing to the effects of its resistance and its capacity (p. 122). Both resistance and capacity could be diminished by increasing the size of the cable, but this involves a great increase in cost, both of the cable itself and of its laying. Thomson, however, showed that an improvement could be made by earthing the end of the cable immediately after the sending of the current, and still more improvement by employing a reverse current before earthing. But the greatest improvement he made was in the type of instrument used for receiving the message. The electrician in charge of the Atlantic cable advocated the use of a heavy magnetic relay for observing the signals, and a very high electromotive force produced by an induction coil for sending. Thomson pointed out several objections to this method, and advocated a battery of ordinary cells for sending, and a delicate galvanometer for receiving. Had Thomson's advice been followed, there is little doubt that the Atlantic cable which was completed on August 5, 1858, would have rendered efficient service. But unfortunately the high voltage system was employed, with the result that the insulation of the cable rapidly deteriorated, and by October 20 the cable was entirely useless. Of the messages, numbering several hundred, which had been transmitted through the first Atlantic cable, every one had been received by Thomson's reflecting galvanometer.

Of the later and more successful attempt to lay an

Atlantic cable little need be said. The ship *Great Eastern*, the largest vessel then afloat, was chartered for the purpose, being the only vessel capable of carrying the entire cable, which was heavier than the earlier cable, having a weight of 1·8 tons per nautical mile. On July 14, 1865, the shore end of the cable was laid at Valentia, and the voyage begun. The cable broke, however, after 125 miles had been laid, and the *Great Eastern* returned. On July 13 of the following year, a new cable having been constructed, the *Great Eastern* started again, completing the journey on July 27. The task of picking up the broken cable of the previous year was then undertaken and completed successfully, and by September 8 the end of this second cable was safely landed at Newfoundland. The



FIG. 65.—Submarine cable.

only great improvement in submarine telegraphy which followed, was the employment of the siphon recorder, which has already been described. This rendered the speed of receiving much greater than could be attained by the mirror galvanometer, and had the further advantage of producing a permanent and automatic record of the message.

The form of a submarine cable will be understood from Fig. 65, which represents an early form of Atlantic cable. Fig. 65 (a) shows the general view of the cable, and Fig. 65 (b) a cross-section. The core consists of 7 copper wires each of 1 millimetre diameter and embedded in gutta-percha, put on in layers. Then follows a layer of hemp and outside this a layer of steel wires each wire surrounded by hemp. The wires all run spirally along the cables.

In modern cables more protective layers are used, and in shallow tropical seas, where certain submarine animals bore into the cable, a layer of brass tape surrounds the insulator. Galvanized iron wires give mechanical strength to the cable, and are prevented from corrosion by several protective layers of prepared tape.

CHAPTER VIII

THE TELEPHONE

WHEN the principal laws of the electric current have been elucidated, the applications in which the heating effect which is employed to render the filament of a lamp incandescent, and the forces of considerable magnitude met with in the electromotor, cease to cause wonder, but in the case of the electric telephone, the currents are so small and the mechanical movements reproduced are so minute that wonder at its success never grows less. Indeed, if the telephone were described to anyone without a demonstration of its performance, there is little doubt that it would be pronounced as unworkable. Nevertheless, Alexander Graham Bell, in 1876, after many failures, succeeded in showing that sounds occurring at one place could be reproduced at another by means of a very simple device. In fact, the method adopted by Bell is still used, in an almost identical form, in all telephone receivers. Later experimenters have altered the design, but have not added any new principle to the Bell receiver.

On causing the poles N, S of a permanent magnet (Fig. 66) to approach a thin sheet of iron AB, many of the magnetic lines of force from the poles pass on to and through the iron sheet, and this we recognize as the condition for N to attract the iron sheet or diaphragm at A, and S to attract the part at B. When AB is very close to the poles of the magnet there is an easy magnetic path from pole to pole through the iron diaphragm, and when AB is far away there is a considerable length of air path

present in addition to the path in the iron. In the former case there will be more lines of force present than in the latter. Hence, if AB is moved to and fro, the number of magnetic lines of force will vary. Since these lines all pass down the iron magnet, they must also pass through the two coils C and D, wound round the tips of the poles, and because their number is continually varying, electromotive forces are produced, and, if the circuit CD is complete electrically, currents are produced in these coils. Another way of looking at it is to consider that magnetic poles are produced on the iron diaphragm due to the proximity of N and S, and if the diaphragm now vibrates, these poles are

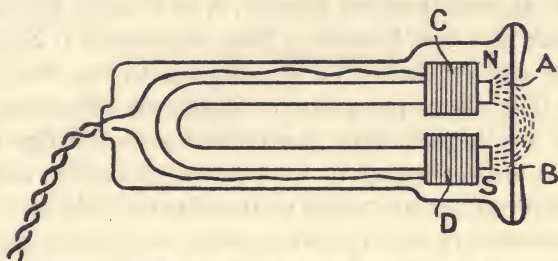

FIG. 66.—Bell telephone.

continually approaching and receding from the coils CD. This is the condition for currents to be produced in CD, as was seen in the experiment illustrated in Fig. 20.

In the act of speech, or any other production of sound, the air is continually being compressed and rarefied. Every time that the air is compressed, a state of compression travels forwards, and every time that it is rarefied, a state of rarefaction travels forwards. Thus, during the production of sound, waves of compression and rarefaction are produced by the sounding body. These waves, falling upon the drum of the ear, set it in motion; the compressions drive it in and the rarefactions draw it out. When the drum of the ear is caused to vibrate, the inner mechanism of the ear, together with the auditory nerve, convey the sensation to the brain which we call "sound," but how this

physiological process of the inner ear is carried out does not here concern us.

The diaphragm AB of the telephone behaves in a similar manner to the drum of the ear, being driven in by the compressions in the sound waves and drawn out by the rarefactions. This motion, as has been seen, causes currents in the coil CD. The instrument is known as the **transmitter**, and its function is to produce variations in electric current in the coil CD, corresponding to the compressions and rarefactions of the sound wave falling upon the diaphragm. These variations of current are very small, and would be difficult to detect without a similar piece of apparatus whose function is to effect a transformation back into sound waves. This instrument is called the **receiver**, and is similar in all respects to the Bell transmitter (Fig. 66). Its action is simpler to understand than that of the transmitter; for the coils on the tips of the magnets are connected in series with the similar coils CD of the transmitter by means of the line or cable connecting the transmitting and receiving stations. Hence the same currents and variations in current occur in the coils of both instruments. One direction of the current increases the strength of the magnetic poles N and S and the diaphragm is pulled in. As the current becomes weaker, or is reversed, the poles are weakened and the elasticity of the diaphragm itself causes it to recover and hence to move outwards. Thus it is kept vibrating at a rate similar to that of the diaphragm of the transmitter, and it therefore sets up waves which have the same frequency as the sound waves which fell upon the transmitter. In this way the sounds are reproduced. A Bell receiver is shown in Fig. 67, in which a bar magnet M is used, the coil being a flat bobbin BB. D is the diaphragm, LL the leads of the coil, and E a conical mouthpiece.

The only great alteration of the telephone from the above described type is due to the introduction of the principle of the **carbon microphone** of D. E. Hughes (1877).

If two pieces of carbon are placed in contact, a current can flow from one to the other through the contact. But on varying the pressure between the two carbons, the resistance changes. Increasing the pressure causes a drop in the

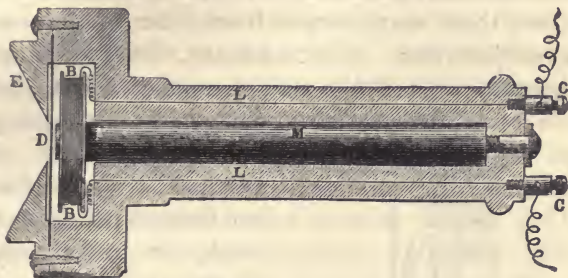

FIG. 67.—Bell telephone receiver.

resistance. Consequently if the carbons are part of an electric circuit of low resistance, which includes a cell or battery, variation in the pressure of the carbon contact will cause comparatively large variations of the current in the circuit. This may be

demonstrated in a manner shown in Fig. 68, in which a carbon block AB with pointed ends rests between two other carbon blocks C and D. This arrangement is situated in a current circuit with the cell G

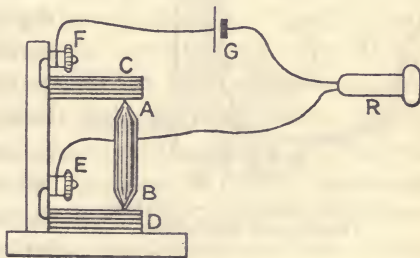

FIG. 68.—Carbon microphone.

and a Bell telephone receiver R. Any slight mechanical disturbance of AB causes a sound to be heard in the receiver. The mechanical disturbance causes variation in pressure between the carbon surfaces in contact at A and B, with consequent variation in electrical resistance, thus causing the current in the circuit to change, with production of motion of the diaphragm of the receiver. So sensitive

is this arrangement that if a watch be placed on the carbon block C its ticking can be heard in the receiver R, although this may be a considerable distance from C.

Although the contacts between the carbons of Fig. 68 are fairly sensitive, they are somewhat unreliable, and are apt to lose their sensitiveness from time to time and to require readjustment. It is customary, therefore, in modern telephones to replace the single contact by a multiple

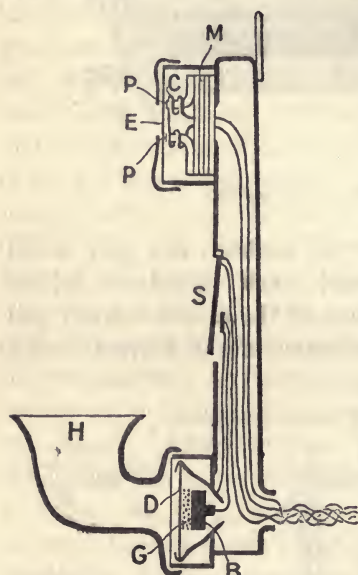

FIG. 69.—Hand set—combined receiver and transmitter.

contact, by employing carbon granules or pellets situated between a thin carbon diaphragm and a carbon block, in constructing a microphone for use as a telephonic transmission.

A combination transmitter and receiver as commonly used is illustrated in Fig. 69. The sound waves entering by the ebonite mouthpiece H fall upon the carbon diaphragm D. This is situated at a short distance from the carbon block B, and electrical contact takes place between them through a number of carbon pellets or granules G. The

movement of the diaphragm causes variations in the contacts between the granules and so varies the current. If the granules become wedged together and the transmitter so loses its sensitiveness, a shake given to the instrument will usually restore it to proper working condition.

The receiver in Fig. 69 deserves notice, as it is of a very efficient form. The permanent magnets M are rings of hard steel, so magnetized that the opposite ends of a diameter, where the soft-iron horns PP are attached, are

respectively N and S poles. This maintains the soft-iron horns PP in a state of magnetization, one being a N pole and the other a S. The iron diaphragm nearly touches PP, and the coils C connected with the transmitter at the distant station are wound upon these pole pieces. The variation of the current in these coils causes the motion of the diaphragm P, as in the original Bell receiver. It was known quite early in telephone practice that the iron core upon which the coils were wound should be permanently magnetized, either by means of a current flowing continuously, or by means of a permanent magnet. The latter is the more economical means, because it does not involve the continual expenditure of energy; and further, the wires which will carry the feeble varying current used in the reproduction of sound would have to be increased considerably in thickness if the much greater current required to produce magnetization of the iron core had to be carried.

The reason for the permanent magnetization is not far to seek. It is clear that the amount of movement of the diaphragm must be great for the production of loud sounds, and that the movement of the diaphragm is proportional to the variation of the force between the poles of the magnet and the diaphragm. The force itself is proportional to the product of the pole strength of the magnet and the induced pole strength on the diaphragm produced by the magnet. Hence the variation in pull is ultimately proportional to the variation of the *square* of the pole strength of the magnet. Now the variation of the square of a quantity is greater, the greater the quantity itself, so that to get a large motion of the diaphragm, the magnetization must be great to begin with. For this reason the permanent magnet is always employed, so that feeble variation in the current in the coil will produce relatively large motion of the diaphragm.

The actual motion of the diaphragm in order to produce audible sounds is surprisingly small. It was shown by the late Lord Rayleigh that the motion to and fro of

the particles of the air for the production of an audible sound did not exceed 0·0000008 centimetre, or 0·00000003 of an inch.

For many years there was hardly any other form of telephone receiver used than the Bell type, but lately several loud-speaking telephones have been devised. Of these perhaps the best known is the "Brown loud speaker," made by Messrs. S. G. Brown, Ltd. In this form the electro-magnet does not influence the diaphragm directly, but is placed under a reed A (Fig. 70) which is

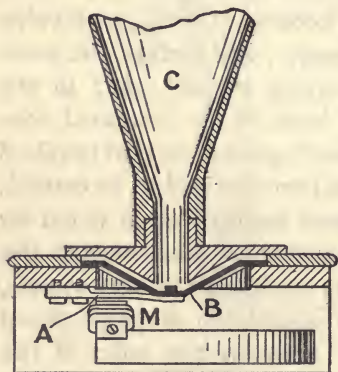

FIG. 70.—S. G. Brown loud speaker.

attached to the bottom of a conical diaphragm B, immediately under the large horn or trumpet C. The reed is acted upon by the electro-magnet M, the windings of which carry the current. This form is largely used in wireless telegraphy, and enables the sounds received to be heard by a number of people simultaneously.

An extremely important modification of the telephone system, which has resulted in the extension of the distance over which telephony is effective, consists in the application of the transformer. Since the loudness of the reproduction depends upon the variation in current in the circuit, and this again depends upon the variation in resistance at the microphone contact, it follows that if the resistance at the contact is a small part of the whole resistance of the circuit, any variation in it cannot make a large variation in the resistance of the whole circuit. It follows that the current changes produced by the microphone are too small to produce efficient transmission, when the length of the cable connecting the two stations is so great that its resistance is considerable. By interposing a transformer, the microphone

circuit and the receiver circuits are separated, so that the above objection no longer applies.

Let P_1S_1 (Fig. 71) be a small transformer (p. 58), of which the primary coil P_1 is in series with the carbon microphone T_1 and battery B_1 . On speaking into T_1 , variations in current are produced in P_1 , and therefore varying electromotive forces arise in S_1 and produce varying currents in the secondary circuit $S_1L_1L_2S_2R_2L_2^1L_1^1R_1$ in which the telephone receivers R_1 and R_2 are included. The lines L_1L_2 and $L_1^1L_2^1$ may be a twin wire connecting the two stations, or in some cases, $L_1^1L_2^1$ is an "earth return," that is, the circuit at L_1^1 and L_2^1 is connected to

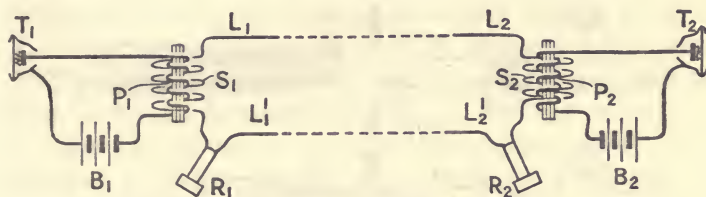

FIG. 71.—Telephonic circuits with induction coils.

some conductor in good contact with the ground, such as a water supply pipe, in which case the circuit is completed through the earth itself.

It will be seen that the primary circuits $T_1P_1B_1$ and $T_2P_2B_2$ are both local and of low resistance, which is the condition for most efficient working of the microphone. The high resistance of the line connecting the stations is now of little objection, since it is in the circuit of the secondary coil of the transformer, which always has a fairly high resistance, and the receiver, which may now also have a fairly high resistance. With a system such as this, telephony is carried on with efficiency over distances of several hundreds of miles.

In order to render telephonic service convenient, devices for switching in an electric bell instead of the microphone circuit, by the act of hanging up the receiver, and for

ringing up the distant station, are employed. Also central exchange systems have come into common use, where the instruments for many subscribers are connected to one central point, so that any one subscriber can be put into communication with any other. Also trunk lines connect distant exchanges with each other. The various systems by which these exchanges are worked do not involve any new principle, and only one of the special devices for intercommunication between subscribers will be described here. This is the **jack and plug** shown in Fig. 72. The lines from a subscriber's instrument are attached to two springs A and B, which make contact with C and D when the plug

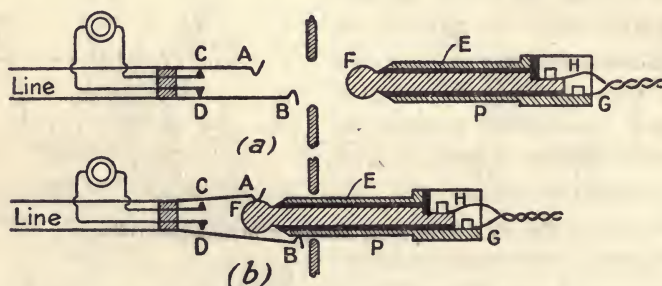

FIG. 72.—Plug and jack for telephone exchange.

P is not inserted. C and D are connected with some form of indicator, either bell, buzzer, or small electric lamp, at the exchange, which is actuated when the subscriber lifts his receiver from its hook. The plug has two conducting parts E and F, separated by a sleeve of ebonite, shown black in the diagram. Of the leads attached to the plug, H is connected to F and G to E, and these leads go to a similar plug at the other end of the short piece of flexible twin wire. When the subscriber "rings up" the exchange and asks for a particular number, the exchange operator puts the plug P into the jack as shown in Fig. 72 (b). F makes contact with A and E with B, and A and B are at the same time lifted from the contacts C and D. A similar plug attached to G and H performs a like operation

at the end of the line of the subscriber who is called up, and the two subscribers are now in communication through the exchange.

The subject of wireless telephony will be left to Chapter X, on wireless telegraphy.

One of the most difficult problems facing the telephonic engineer is that presented by **distortion**, or the change in the character of the waves travelling along a line, so that the movement of the diaphragm of the receiving instrument is not a faithful copy of that of the transmitting diaphragm. In order to understand this point, it must be realized that speech consists of a very complicated motion of the air in the cavities of the throat and mouth of the speaker. This motion is the sum or resultant of several simpler motions, each constituting a note or sound of definite frequency or pitch. To take first a case which is much simpler than that of the human voice, consider a stretched string, such as that of a piano or a violin. Any given string, when plucked or struck, vibrates at a given rate, and starts air waves at the same rate, by means of which we hear it and recognize the pitch. The middle C of the piano corresponds to 512 vibrations per second, which is called its **frequency**. The octave lower is produced by a frequency of half this, or 256 vibrations per second, and the octave higher by double, or 1024 vibrations per second, and so on for the other notes. But a string does not as a rule vibrate in one piece only, the two halves vibrate with double the frequency of the string vibrating as a whole, and the thirds and quarters and so on vibrate at three times and four times the frequency respectively, so that, in the case of an actual string, the sound heard by the ear is very complicated. The harmonics, or overtones, as they are called, which are produced by the vibration of the segments of the string, give character or quality to the note, and it is by means of them that we recognize the note as being due to a string, or a tuning-fork, or an organ pipe, as the case may be. The ear has such a delicate sense of perception that

two or more instruments sounding the same note at the same time can be recognized, and even their quality appreciated. Still greater is the complexity in the case of the human voice. Each sound, such as a vowel, or a consonant sound, has definite pitch, but is so rich in overtones that it can be recognized by means of them. In order to transmit speech by telephone, the variations of current in the line must correspond exactly to the movements in the air which constitute the sound. In Fig. 73 (*a*) is shown a curve which gives the current in a telephone wire when the word "pea" is pronounced; the scale at the side shows that the current never reaches 10 micro-amperes, a micro-ampere being one-millionth of an ampere.

Following the quiescent stage 1 is a sudden or explosive sound at 2, corresponding to the consonant "p," and \bar{e} is the vowel or "ee" sound. Similarly at Fig. 73 (*b*) is shown the current for the sound "f." Each of these consists of a particular mixture of notes of various frequencies, and although the eye does not recognize the shapes of the curves, the ear would recognize the sounds when the diaphragm of the receiver vibrates in accordance with these variations of current.

Now, in the process of transmission along a telephonic wire, every current dies away with increasing distance from the sending station, that is, the currents become *attenuated*. Generally speaking, the attenuation depends upon the frequency of the variations of current, so that on arrival at the receiving station, the various components of the original current are attenuated to different extents, and the resulting sound differs in quality from that transmitted. This distortion is usually only slight on telephone lines covering short distances, but becomes considerable with the use of underground cables or submarine cables. In Fig. 73 (*c*) is seen the current curve at the sending end of a telephone cable, and (*d*) is the corresponding current at the end of the unloaded cable twenty miles in length. A glance at these two curves will make it clear that a great deal of the finer

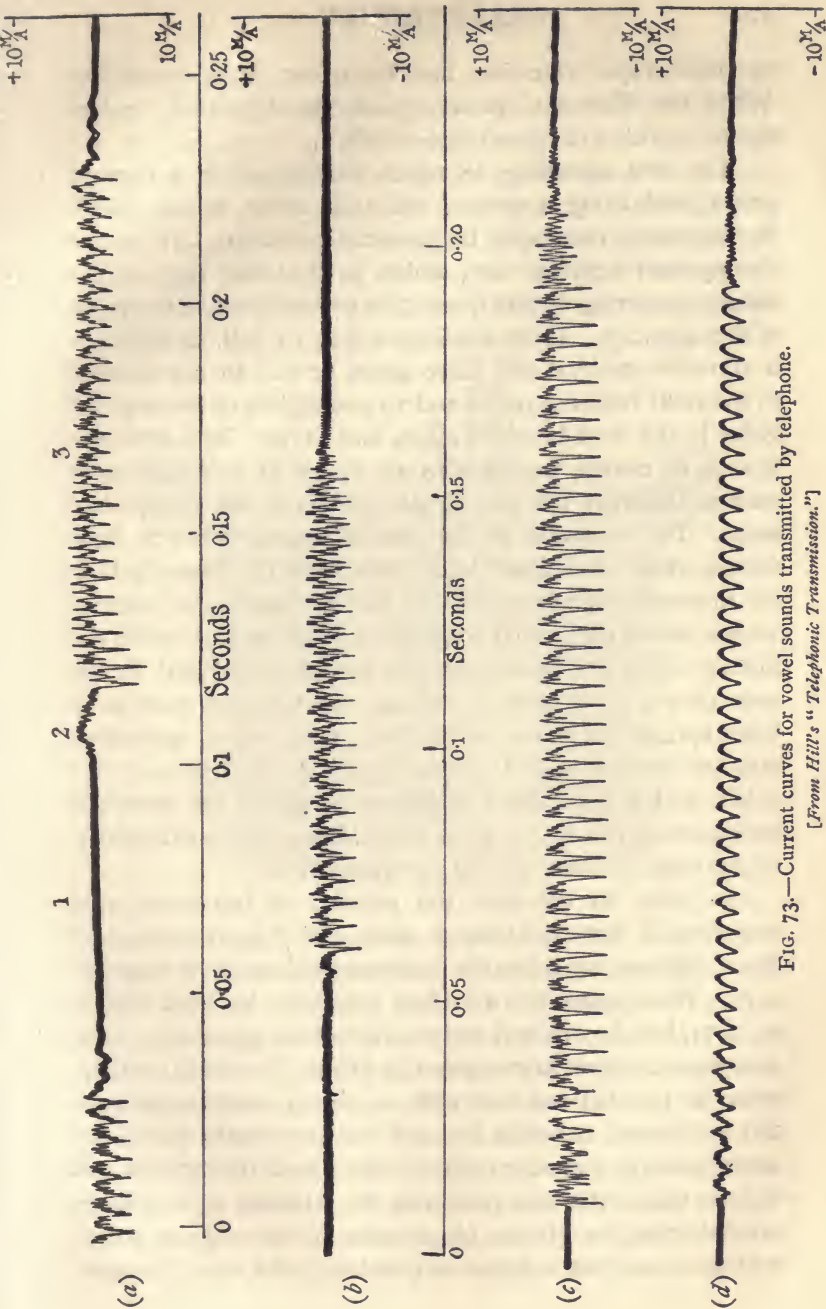

FIG. 73.—Current curves for vowel sounds transmitted by telephone.
 [From Hill's "Telephonic Transmission."]

or more rapid vibration has been lost in transmission. When the distances are very great, the distortion renders the recognition of speech impossible.

The law according to which oscillations in a current propagated along a wire or cable die away, is one which is frequently met with in physical problems. It is the "compound interest" law, which is, that the rate of the change occurring in any quantity is proportional to the value of the quantity. If an oscillation dies to half its value in a 100-mile cable, it will halve again, or fall to one-quarter in the next hundred miles, and to one-eighth of the original value in the next hundred miles, and so on. This attenuation is, of course, common to all modes of propagation of waves, although the law of attenuation is not always the same. For example, in the case of sound waves or light waves, which spread out in all directions, the intensity falls off inversely as the square of the distance. In wireless waves, which spread out over the surface of the earth, the falling off is nearly inversely as the distance; but in the case of waves of current passing along a wire, such as a telegraph or telephone cable, there is no actual spreading out, but there is a leakage through the insulation of the cable, and a dissipation of energy owing to the electrical resistance of the wire. Hence the higher the conductivity of the cable the less will be the attenuation.

In order to calculate the velocity of transmission of variation of current along a cable, and the attenuation of the variations, considerable mathematical analysis is necessary. These quantities were first calculated by Lord Kelvin in 1855, but he omitted certain important quantities. The complete calculation was given by Oliver Heaviside in 1887, when he pointed out that with a certain relation between the resistance, capacity, leakage, and magnetic effect, the attenuation of the waves is the same for all frequencies. It follows that if this condition can be attained, there will be no distortion, for all the frequencies in the original sound will preserve their original proportion in the wave, however

far it is propagated along the cable, since the oscillations of all frequencies will be attenuated to the same extent.

The required relation between the constants of the cable for distortionless transmission is disturbed in the case of most cables, particularly underground and submarine cables, by the electric capacity being disproportionately great with reference to the magnet effect. The capacity cannot very well be reduced, but there are many devices for increasing the magnetic effect of the current. One of

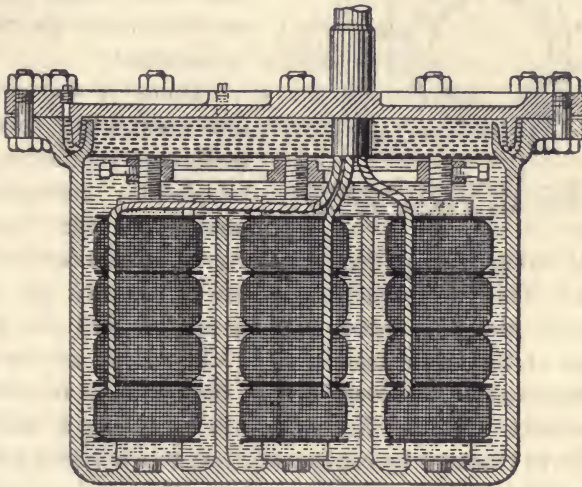

FIG. 74.—Loading coils.

these is to wind iron wire round the cable, because the magnetic effect is greater with iron surrounding the current than when no magnetic material is present, as we have seen in Chapter II. This method has many advantages, but there is one great disadvantage, the size and weight, and therefore the cost, of the cable are considerably increased. Another method, which has met with considerable success, is to place iron-cored coils in the cable at regular intervals, and it was shown by Prof. M. I. Pupin in 1899 that the advantages of continuous loading may still be obtained, although the loading is now to be done at separate points.

A box of coils, such as is used in the United Kingdom for underground cables, is illustrated in Fig. 74, with the winding of the separate coils (Fig. 75). The cases may contain coils for 98 lines, but it is preferable not to exceed 50. The lines are collected and brought out of the case all together, where they are jointed to the cable. Such loading or "Pupin" coils are placed at intervals of several miles,

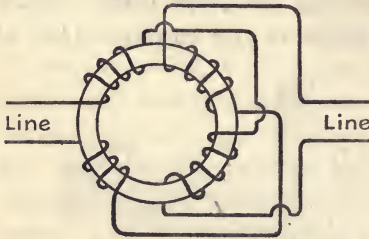

FIG. 75.—Arrangement for magnetic balancing of loading coil.

and their use has vastly increased the distances over which clear and recognizable speech can be transmitted.

There is also coming into extended use a method of reinforcing the telephonic currents at points on the line at

which, owing to distance, the currents have become very feeble. This was attempted without success by many forms of relay, but none was successful until the introduction of the triode tube was developed for use in wireless telegraphy. A description of the triode is necessarily postponed to Chapter X. It is now becoming a common practice to transmit by cable-telephone to a wireless station, where the telephone currents actuate the wireless set, the wireless waves covering hundreds of miles of sea and being eventually transformed to ordinary cable currents, thus completing the travel between towns in far distant countries.

CHAPTER IX

ELECTROLYSIS AND BATTERIES

THE early history of electrolysis may be identified with that of current electricity, and has already been outlined in Chapter I. Volta's discovery of the production of current by his "pile" opened the discussion as to the origin of the electric charges produced; that is, whether they are produced by chemical means or by the mere contact of dissimilar metals. But this discussion is now of academic interest only. The discovery of Nicholson and Carlisle was the beginning of the actual study of electrolysis, and many investigators examined its phenomena under various conditions. In particular, the first separation of the metals sodium and potassium by Sir Humphry Davy, in 1807, should be noticed. The nature of soda and potash were not known until Davy, applying a battery of 250 cells to the fused salt, obtained a small globule of soft metallic substance which burned readily in air, with a yellow flame in the case of the metal from soda, and a violet flame in that of the metal from the potash.

Passing on, the next notable investigation was that of Faraday, which placed our knowledge of the quantitative laws of electrolysis in the form which is still held to be valid. Nearly one hundred years have elapsed since the statement of these laws by Faraday, but they still represent the truth, to the highest order of accuracy of measurement of which we are now capable. Faraday's laws of electrolysis are two in number, the first stating that the amount of any electrolyte decomposed by the passage of a current

is proportional to the quantity of electricity which passes. Whether a small current flows for a long time or a strong current for a short time does not matter, the amount of chemical effect is proportional to the product of current and time, which measures the amount of electricity which passes. Thus—

Quantity of electricity = current \times time.

Since the practical unit of electricity is called the **coulomb**, this relation may be written in the form—

Number of coulombs of electricity passing in a circuit
= current in amperes \times time in seconds.

The second law of Faraday refers to the effect observed when different materials are used as electrolytes, and states that the amount of substance liberated by a given quantity of electricity passing through the electrolyte is proportional to the chemical equivalent of the substance. This law is of far-reaching importance, and it is worth while to consider it carefully. Chemistry, as a modern science, is built up on the theory that matter consists of atoms of about ninety different types, each type corresponding to an element. The atom of hydrogen is the lightest, and calling its weight unity, that of the atom of the element oxygen has weight 16, copper 63.6, chlorine 35.5, silver 108, sodium 23, zinc 65.4, and sulphur 32. These numbers are only approximate, their values as found by the latest determinations need not concern us here. Since no quantity of matter less than an atom can take part in any chemical process, the simplest form of a compound of, say, sodium and chlorine, is represented by the formula NaCl, Na representing an atom of sodium or natrium, and Cl an atom of chlorine. From the numbers given above, sodium chloride (NaCl) consists of sodium and chlorine in the proportions 23 of sodium to 35.5 of chlorine by weight. Similarly, hydrochloric acid (HCl) consists of hydrogen and chlorine in the proportion 1 of hydrogen to 35.5 of chlorine, since each atom of hydrogen

combines with one atom of chlorine. Hydrogen, chlorine, sodium, etc., are called mono-valent elements, because each atom of one combines with one atom of the other. But some substances are di-valent, that is, an atom combines with two mono-valent atoms. Thus water (H_2O) consists of hydrogen and oxygen in the proportion 2 by weight of hydrogen to 16 by weight of oxygen, or two atoms of hydrogen to one of oxygen, and we see that oxygen is a di-valent element. Similarly, copper and zinc are di-valent, while silver is mono-valent. Now the chemical equivalent of a substance is the weight of it which can combine with 1 gramme of hydrogen, or with the amount of any substance that would combine with 1 gramme of hydrogen. Thus the chemical equivalent of chlorine is 35.5 and of sodium 23, since 35.5 grammes of chlorine would combine with 1 gramme of hydrogen, and 23 grammes of sodium would combine with 35.5 grammes of chlorine. On the other hand, if we take the case of copper or of zinc, copper chloride ($CuCl_2$) and zinc chloride ($ZnCl_2$) indicate that an atom of copper or of zinc is di-valent, and the chemical equivalent of copper is not 63.6, but half of this, or 31.8, and of zinc $65.4/2$ or 32.7. It must not be forgotten that radicles can act as elements; thus in nitric acid (HNO_3), NO_3 is mono-valent, with a chemical equivalent of $14 + 48$ or 62, while in sulphuric acid (H_2SO_4), SO_4 is di-valent, with a chemical equivalent of $(32 + 64)/2$ or 48. Thus the second law of electrolysis, as given by Faraday, means that the current which, in a given time, would liberate 1 gramme of hydrogen, would also liberate 8 grammes of oxygen, 108 grammes of silver, 23 grammes of sodium, 62 grammes of NO_3 , 48 grammes of SO_4 , 31.8 grammes of copper, or 32.7 grammes of zinc. This may be represented in a simple manner, as in Fig. 76. The vessels contain solutions of hydrochloric acid, silver nitrate, sulphuric acid, and copper sulphate. Then, since the cells are all in series, it is clear that the quantity of electricity which passes through all the cells is the same; for the current

must be the same in them all, and the time for which the current flows must be the same for them all. It follows from Faraday's second law, that if the current flows until 1 gramme of hydrogen is liberated in any one of them, then for every cell in which hydrogen is liberated, 1 gramme will also be the amount, and in the other cases, the amounts liberated will be the chemical equivalents of the respective substances. Of course, the substance liberated may or may not retain its form. Thus the copper or silver would remain as copper or silver coatings of the electrode. Hydrogen would bubble away as gas, but SO_4

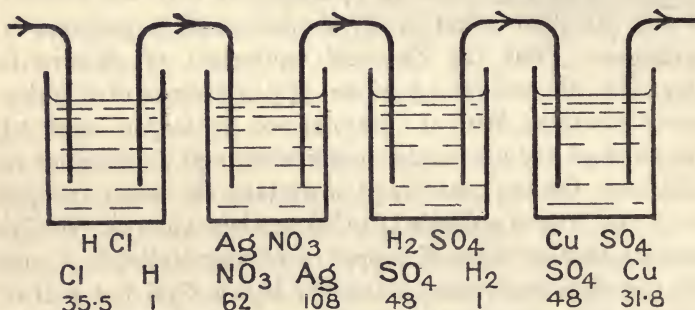

FIG. 76.—Electrolytic cells representing the laws of electrolytes.

would attack the electrode and form a sulphate, or attack the water and form a gas, as explained on p. 15.

Faraday himself saw that the two laws of electricity which he enunciated were the expression of some deep-seated law, and that when the facts of electrolysis became more clearly understood, our knowledge of the constitution of matter would at the same time be widened. For the laws of electrolysis may be put in another form, which is more striking, but is not so useful for the everyday purposes of calculation, namely, that every mono-valent atom carries the same amount of electricity, which therefore appears to be a natural fundamental quantity; every di-valent atom twice this amount, every tri-valent atom three times this amount, and so on. This follows from the

fact that the atomic weights of the mono-valent atoms are their chemical equivalents, the atomic weights of the di-valent atoms are twice their chemical equivalents, etc.

All substances in their usual state are neutral as regards electricity, but mono-valent atoms can acquire a positive or a negative charge of electricity, and in the solution are driven by the electric field, established by the external battery or dynamo, towards the kathode if the charge they possess is positive, as in the case of hydrogen or the metals, and in the opposite direction, that is towards the anode, if the charge is negative, as in the case of the acid radicle. It is thus seen that the current in the electrolyte consists of two drifts of atoms, positively charged atoms towards the kathode and negatively charged atoms towards the anode. That this is the explanation of the process of electrolysis we owe to Svante Arrhenius (1887), who considered that the compound in solution was partially or wholly dissociated or split up into its atoms or radicles, which possessed charges in accordance with Faraday's laws, and that when these charged atoms arrived at the conducting electrodes, the charges were given up to the electrodes, while the atoms again acquired their ordinary neutral condition. This dissociation theory soon replaced the older theories, in which it was considered that the compound was actually split up in the process of electrolysis. The work of J. H. van't Hoff, W. Hittorf and others filled in the details of the dissociation theory. The strongest support followed from the facts that other and non-electrical methods showed that the number of particles in the solution was in excess of the number of actual molecules of the substance dissolved, the excess being produced by the dissociation of some of the molecules into the constituent atoms.

One of the most important uses of our knowledge of electrolysis is the application to the measurement of electric current. A consideration of Faraday's laws of electrolysis shows us at once that if the actual amount of any one substance liberated by a known current in a known time can

be found, the amount of the same substance liberated by any other current in any time can be calculated, and the amount of any other substance liberated can be found from a knowledge of the chemical equivalent. For this purpose it is useful to reduce the current to one ampere and the time to one second, and to give a name to the quantity of any substance liberated. This quantity is called the **electro-chemical equivalent** of the substance. The electro-chemical equivalents of the different substances are, from Faraday's second law of electrolysis, proportional to their chemical equivalents, and it is of the utmost importance to determine once for all, as accurately as possible, the electro-chemical equivalent of some substance. This determination was undertaken by Lord Rayleigh and Mrs. Sidgwick in 1884, the substance chosen being silver. The choice fell upon silver for several reasons. Silver has the largest known electro-chemical equivalent, having a fairly high atomic weight and being mono-valent. It forms a very hard pure metallic layer when deposited by electrolysis under suitable conditions, and silver is a fairly common substance, the salt, silver nitrate, being easily procurable in a fairly pure form. The apparatus used in the measurement of electric current or the determination of the electro-chemical equivalent is called the **voltmeter**, and the form of the silver voltmeter usually employed is shown in Fig. 77. PB is a platinum dish or basin supported upon a conducting base B and containing a solution of silver nitrate. A plate of silver is immersed in the solution, being carried by the rod SA. T and T are the terminals by which the current enters and leaves. The current enters the solution by the plate, which is therefore the anode, and the platinum dish is the kathode, and receives the deposit of silver. The dish is first cleaned with nitric acid, washed, dried, and weighed. The time for which the current passes is noted and on the cessation of the current, the basin is again washed in pure water, dried, and weighed. The increase in weight is the weight of the silver deposited, and in Lord Rayleigh's experiment the

current was determined by means of a current balance in which the force between two coils carrying the current is found by weighing. From these data the electro-chemical equivalent of silver was found to be 0.001118 gramme per ampere per second. Later determinations have shown it to be 0.00111827. Once the electro-chemical equivalent is known, the method of the voltameter may be used for the measurement of current. The experiment is carried out exactly as before, but instead of calculating the electro-chemical equivalent from the known current, the order is

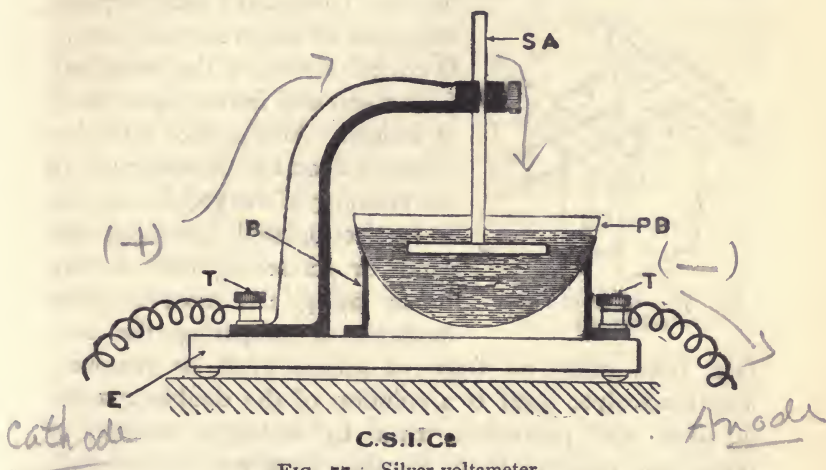

FIG. 77.—Silver voltameter.

reversed, the current being calculated from the known electro-chemical equivalent. This method is extremely useful and is generally employed in the standardization of current-measuring instruments such as the ammeter. When the accuracy required is not very great, the copper voltameter may be used. Three copper plates supported by metallic rods carried by wooden supports AB, Fig 78, dip into a solution of copper sulphate. The outer pair of plates acts as anode and the middle plate as cathode. The washing and weighing is carried out as in the case of the silver voltameter, and the process is similar.

Many industrial processes are founded upon the phenomenon of the electro-deposition of one metal upon another, generally a rare metal upon a common one. This may be for the purpose of ornament or for preservation. The innumerable instances in which silver is deposited upon the commoner metals need only be mentioned, electroplated, or "plated" goods being very common. In electroplating, the chief necessity is to produce a hard adhesive coat, which, in the case of silver, is matt or rough, but may easily be burnished, to give the ordinary bright metallic lustre.

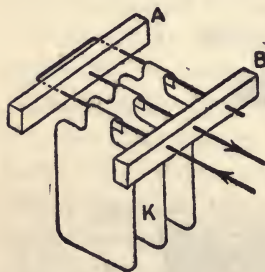

FIG. 78.—Plates of copper voltameter.

To ensure a hard deposit, care must be taken that the current is not too strong, or the metal will form a soft and friable layer which is useless. Also perfect adhesion depends upon the thoroughness of the cleaning of the article which is to be electroplated, scrubbing with sand or scratching with a wire brush being the most effective methods of preparing the surface, from which all trace of grease must be removed.

The electrolyte itself is a solution of the double cyanide of silver and potassium, made by adding a solution of potassium cyanide to a solution of silver nitrate until the heavy white precipitate, which is formed at first, completely disappears, giving a clear solution ready for electroplating. The article to be plated, after being carefully cleaned, is hung up in the solution by a wire and connected to the negative terminal of a battery, so that the current leaves the electroplating bath by way of the article, which therefore acts as the kathode. The anode should be a plate of silver, so that as silver is deposited upon the article, fresh silver goes into solution, and the strength of the bath does not change. Electro-gilding is carried out in a manner similar to that of electro-silvering, the solution in this case consisting of 1 part of gold chloride to 10 parts

of potassium cyanide to 200 parts of water. Silver and bronze are easily gilt, but to gild iron, zinc, or tin it is necessary first to deposit a layer of copper, then upon this to deposit the gold.

Several other metals are used, to a limited extent, for plating, among which may be mentioned nickel, on account of its protective property, zinc, and even brass. By employing both copper and zinc in solution as the electrolyte and an anode of brass, the two metals may be deposited upon iron or steel articles, and form a layer which effectually prevents rusting. The electro-deposition of brass is much more difficult than that of the pure metals, but by regulating the process carefully, a red brass, rich in copper, or a pale brass, rich in zinc, may be deposited.

By far the most important of all electrolytic processes is the deposition of copper, either for the effect of the deposited layer, or for the purpose of refining the copper. In the manufacture of copper conductors for carrying the electric current, it is of the utmost importance that a high degree of purity in the metal should be attained; for a very small percentage of impurity will increase the electrical resistivity of the metal to a large extent, causing considerable waste of energy in carrying the current. It so happens that when impure copper is used as anode in an electrolytic cell of copper sulphate, the copper only goes into solution, the impurities merely dropping out as the copper is dissolved, and forming a slime or mud at the bottom of the electrolytic bath. Since silver and gold are two of the impurities commonly occurring in raw copper, the recovery of these metals from the mud deposited is a matter of considerable profit. For the kathode, a strip of pure copper is used, and the deposit upon it being copper of great purity is in the form desirable for the manufacture of electrical conductors. A large proportion of the copper used in the world is now purified electrolytically.

An interesting application of this process is the making of copper tubes invented by S. Cowper-Coles. If the

copper be deposited upon a brass tube carried by a mandrel which is rotated at about 1000 revolutions per minute, the centrifugal action and the friction of the liquid remove all solid impurities as well as bubbles. In this way very satisfactory tubes may be made, and if required, the tubes may be slit and opened out to form sheet.

Another important use of the electro-deposition of copper is the covering of iron or steel articles for the prevention of rust, or as a preliminary coating upon which one of the harder non-corrodible metals may be deposited ; but the process of the most importance of all is that of electrotyping. When a book is to be printed, a vast amount of type has to be set up, and the formes containing type, and probably diagrams, are very bulky. It is therefore usual to electrotype them, that is, make duplicates in the form of copper impressions, from which the actual printing is done, thus releasing a large quantity of type, as well as giving more convenient and permanent plates for the press. When the page has been set up in type, powdered graphite is dusted over it, and a wax composition placed upon it. The wax is then forced on to the type by hydraulic pressure, and on removal constitutes a mould or reverse impression of the type. The wax mould is then powdered with graphite and washed over with a solution of copper sulphate, a few iron filings being sprinkled upon it. This causes a thin film of copper to be deposited chemically upon the graphite, and gives a good conducting surface. The wax mould is now placed in the electrolytic bath, being made the kathode, and a layer of copper deposited upon it. The thickness of the layer depends upon the purpose for which the plate is required, but for ordinary printing, half an hour to an hour usually suffices for the deposition. On removal from the bath, the thin layer of copper is removed carefully from the wax and then forms a perfect copy of the original type. All that now remains to be done is to fill in the thin copper shell with a backing of type metal, melted and poured in to strengthen the plate, and to plane it down

to the right thickness, straightening it if necessary. The plate is then ready for the actual printing press.

There is still another process that may be applied to the electrotype plate, called **steel-facing**. Owing to the softness of copper, the plate soon wears in the process of printing, the finer parts disappearing first. By depositing a thin layer of iron upon the face of the plate, its life may be greatly extended, and moreover it may be re-faced a number of times if necessary, so that its life is extended indefinitely. The electrolyte for steel facing is obtained by using a sheet of iron as anode in a saturated solution of ammonium chloride (sal-ammoniac), a thin iron plate being used as kathode. On passage of the current, iron goes into solution at the anode and hydrogen bubbles away at the kathode. When the solution has acquired sufficient iron, the copper plate which is to be "steel-faced" is placed as kathode in place of the thin iron strip. In the course of half an hour a thin layer of iron is deposited upon the plate, giving it the appearance of polished steel. This layer of iron does not in any way spoil the print obtained from the plate, but it is so hard that the number of good impressions obtainable is much greater than from the unprotected copper plate.

Since the discovery of electrolysis many processes of chemical manufacture have been revolutionized, but their study may appropriately be allocated to the science of chemistry. The reader who desires to follow them is referred to the volume on chemistry in this series, where the manufacture of substances such as soda, carborundum, and acetylene will be found. It is desirable, however, before closing this chapter to trace the formation and evolution of different types of electric cell or battery from the original Volta type to those of the secondary or storage form; which are now extensively used.

Electric cells may be classed under two heads, **primary cells** and **secondary cells**. Primary cells are those in which energy in the chemical form is converted directly into

energy of electric current, whereas current must be passed through a secondary cell before any current can be derived from it. For this reason the secondary cell is often called a **storage cell** or **accumulator**. In the original Volta cell, electrodes of zinc and copper are immersed in, or separated by, a solution of an acid; generally sulphuric acid. As this serves as a type for all cells, we will examine it a little more closely. A rod of ordinary zinc (Fig. 79) when immersed in a solution of sulphuric acid dissolves, forming zinc sulphate, and the hydrogen liberated bubbles away. The equation representing the reaction is—

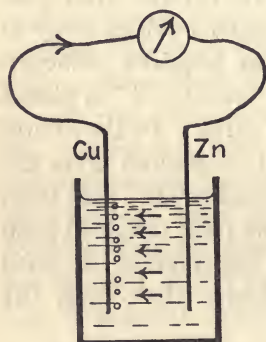
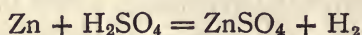

FIG. 79.—Simple voltaic cell.

At the same time heat is liberated. The chemical affinity of zinc for SO_4 implies a store of energy, which can be obtained in the form of heat by the above reaction. Of course the hydrogen also has a chemical affinity for SO_4 , so that a certain amount of energy is necessary for turning it out of the sulphuric acid, and some of the energy is used in this way. But there is still a balance of energy left which

appears as heat. If now we place a copper rod in the solution, as in Fig. 79, and connect it to the zinc by an external wire, the hydrogen no longer bubbles up from the zinc but appears as bubbles upon the copper instead. At the same time a galvanometer in the external circuit will indicate that a current flows from copper to zinc through the wire, and we conclude, since an electric current only flows in complete circuits, that there is a current from zinc to copper through the cell. It follows that the copper is playing the part of kathode, and from the knowledge we have gained, it will no longer cause surprise that the hydrogen is deposited upon it. On the other hand, the

zinc is anode and the SO_4 of the sulphuric acid in solution is deposited upon it, with formation of zinc sulphate (ZnSO_4). It is usual to call the copper the positive (+) electrode of the cell, because the current comes by way of it from the cell, while the zinc is called the negative (-) electrode because the current goes through it into the cell. Also, we know that heat is produced in any conductor through which an electric current flows, so that in this simple case the energy liberated when zinc forms zinc sulphate is not produced directly as heat, but as energy of electric current, which becomes heat in the various parts of the circuit through which the current flows. The energy may also take other forms, for if an electromotor be placed in the circuit, some of the energy may be converted into mechanical work, or, in fact, into any of the various forms into which the energy of the electric current can change. It might be thought that the electric cell affords an economical means of producing energy of electric current; and so it would if zinc were sufficiently cheap. But coal is much cheaper than zinc, and it is far more economical to burn coal in a furnace to raise steam, and to drive a dynamo by means of a steam engine, than to burn zinc directly, for that is what it amounts to, in the electric cell. Nevertheless there are some cases where, on account of the small amount of current required, and the reliability of the cell, it is more efficient to use current from a cell than from a dynamo. Such cases are those of the telephone, electric bell, and the portable flash lamp.

The simple cell of Volta is, however, not very efficient as a producer of electric current. With the arrangement shown in Fig. 79, the current may be fairly strong at first, but rapidly falls off. The cause of this falling off is the hydrogen which collects upon the copper or positive plate, and this for two reasons. One reason is that the hydrogen partially covers up the surface of the plate, and so reduces the effective area for carrying current; and the other is that the hydrogen which, as we have seen, possesses considerable

chemical affinity for SO_4 , tends to go into solution, and produce a current in the reverse direction to the main current due to the solution of zinc. The hydrogen really forms an electrode, and a cell with electrodes of hydrogen and zinc has a less electromotive force than a cell with electrodes of copper and zinc. It is sometimes said that the hydrogen produces a **back-electromotive force**, and that under these conditions the cell is **polarized**. Thus the polarization is objectionable, and many forms of cell have been devised in which the hydrogen is not deposited, or if

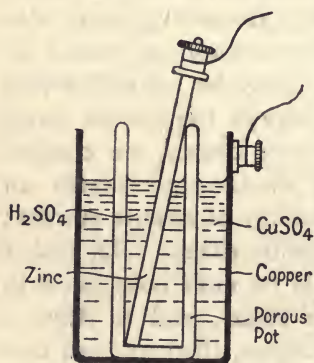

FIG. 80.—Daniell's cell.

deposited is quickly removed; for before the development of dynamo-electric machinery, the cell was the only source of current, and the production of an efficient cell or battery, that is, one that would produce a constant current for considerable time, was a matter of great importance.

Of all the types of cell which have been used, most are now of historic interest only, but there are three kinds which still have important uses. The earliest of these was invented by Daniell in 1836, and is named after him. It has copper and zinc electrodes, but the copper electrode is immersed in a saturated solution of copper sulphate, the zinc dipping into a dilute solution of sulphuric acid. In many forms of the Daniell's cell, the copper electrode also forms the outer containing vessel, as in Fig. 80, but the cell is equally efficient if an earthen pot be used, and a piece of copper sheet be immersed in it. The copper sulphate solution and the acid solution are kept from mixing by means of a pot of unglazed earthenware, or porous pot, through the walls of which the liquids can percolate and so come into contact. The reaction at the negative or zinc electrode

has already been explained, and the reaction at the positive or copper electrode may be easily understood, for the copper is kathode, and being situated in a solution of copper sulphate it follows that copper is deposited. Thus no hydrogen is liberated, and the cell does not become polarized, so that its electromotive force remains very nearly constant whatever current is passing through the cell. The value of the electromotive force is about 1.1 volt. One point in connection with the behaviour of the Daniell's cell deserves attention ; that is, the reaction at the interface of the two liquids. Inside the porous pot there is a drift of SO_4 towards the zinc, and of hydrogen towards the porous pot, and outside, the copper drifts away from the pot and SO_4 towards it. Thus the hydrogen from inside and the SO_4 from outside meet and combine, forming sulphuric acid in the walls of the pot where the two solutions mingle.

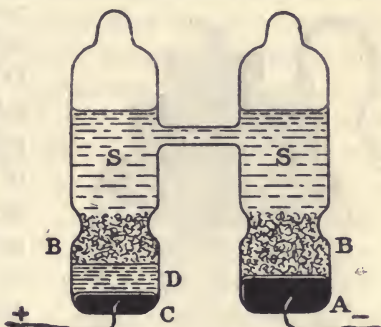

FIG. 81.—Cadmium or Weston standard cell.

The cadmium or Weston cell is of recent origin, and its use is due to the great constancy of its electromotive force. It is illustrated in Fig. 81. The positive electrode C is a pool of mercury upon which rests a paste D of mercurous sulphate. On this rests a paste of cadmium sulphate crystals, and then a saturated solution S of cadmium sulphate. The negative electrode A is an amalgam consisting of 12 parts of mercury to 88 parts of cadmium. When made with carefully prepared pure materials, the electromotive force of the cell is 1.0183 volts at 20° C., and the electromotive force varies very slightly with change of temperature. This cell is accepted as an international standard of electromotive force. It must be used with care, as should any but extremely small currents

pass through it, the electromotive force ceases to have the standard value.

Of all the primary cells used at the present time, Leclanché's is the commonest. Its peculiar merit lies in the fact that it will give a considerable current for a short time, and although it polarizes rapidly, it will recover on being allowed a period of rest. The Leclanché cell is therefore well adapted for telephones and for ringing electric bells, and in fact for any purpose in which an intermittent supply of current is needed. Fig. 82 shows a very common form of the Leclanché cell.

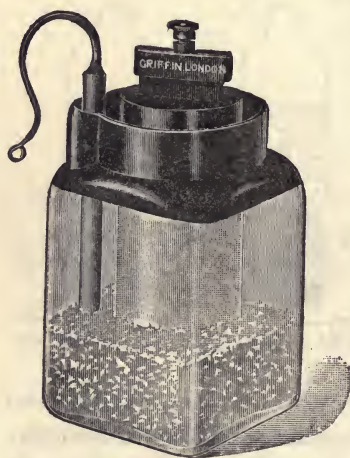
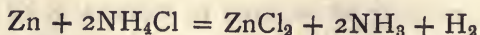

FIG. 82.—Leclanché cell.

The negative electrode is a zinc rod dipping into a strong solution of ammonium chloride (NH_4Cl), commonly called sal-ammoniac. The positive electrode is a plate of gas carbon, and is contained in a porous pot, the space between the carbon and the pot being packed with a mixture of black oxide of manganese (MnO_2) and powdered gas carbon. The solution percolates through the porous pot and the mixture inside, and so reaches the carbon electrode. When

current flows, zinc is dissolved, forming zinc chloride, and ammonia and hydrogen are liberated at the positive electrode, thus—



It is, of course, the hydrogen to which the polarization is due, but this is slowly removed by the oxygen of the manganese dioxide, and the cell is then ready to produce current again—

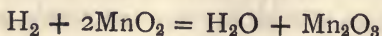

A very convenient form of the Leclanché cell has come into use of late years, namely, the so-called **dry cell**. Of course no cell can be really dry, that is, without liquid, for there is no known solid electrolyte available. But there is no loose liquid to spill, for the ammonium chloride is made into a paste with sawdust and glycerine, enough water being held in this paste for the working of the cell. It is usual to add some substance such as calcium chloride, which absorbs moisture from the atmosphere, and helps to maintain the cell in a damp condition.

Secondary batteries or accumulators play a very different rôle to primary batteries, because they can be constructed to give large currents at fairly constant voltage. They are frequently used in conjunction with direct-current dynamos for the supply of current for lighting, or for motors, the battery being charged while the dynamo is running, and supplying the current when it is not convenient to run the dynamo. The first attempt to make a storage battery was due to Sir W. Grove, who made use of the polarization effect which has already been mentioned (p. 138). He used platinum strips, dipping into dilute sulphuric acid. Each strip is surrounded by a tube containing the solution. On passing a current, hydrogen collects in one tube and oxygen in the other. The platinum strip, surrounded by hydrogen, now acts as positive electrode, and that surrounded by oxygen as negative, and the cell will produce current until the gases have disappeared.

Owing to the smallness of the current which the Grove's storage cell is capable of producing, it did not come into general use. In 1859 Planté used a chemical method of storing the oxygen liberated at the anode. On employing two lead plates immersed in dilute sulphuric acid and passing the current, hydrogen bubbles away at the cathode, but the oxygen at the anode combines with the lead forming lead oxide (PbO_2). On connecting the plates externally, a considerable current can be obtained, the oxidized plate acting as positive electrode. As the current flows, the

oxidized plate is reduced, and the negative plate becomes oxidized, until both plates have come to the same state of oxidation. The reactions may be represented thus :

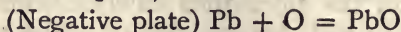
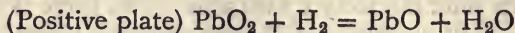

When both plates have come to the same condition, it is clear that the current will cease, and it is necessary to charge the cell again by a current from some external agency in order to oxidize the positive plate again to PbO_2 and reduce the negative plate to metallic lead. The greater the number of times the cell is charged and discharged, the greater becomes its storage capacity, for the layer of lead produced by reduction of the oxide gets deeper and deeper, and since it is of a spongy form, the electrolyte can penetrate deeper and deeper into the plate. In fact, when the plates are made, the current is passed backwards and forwards through them many times in order to obtain a thick layer of spongy lead. This process is called **forming** the plates, and it adds considerably to the cost of production. The length of the forming process may be reduced slightly by building up the plates from strips of lead burnt at the ends into a framework of lead. A further reduction in the time of forming was made by Faure, who used a lead lattice-work and stamped into the interspaces, a paste made of oxides of lead and sulphuric acid. The lead oxide is, of course, reduced on the first passage of the current, so that the time required for forming is almost eliminated. But Faure, or paste plates, are not so strong as formed plates of the Planté type; they are apt to loosen and flake, and may cause grave injury to the cell. Some makers use Planté formed plates for the positives and paste plates for the negatives, because the positive plates are most subject to deterioration in use.

Lead accumulators are constructed of alternate positive and negative plates, the positives all being connected together by a stout lead strip, and the negatives by another

strip, as shown in Fig. 83. The positive strip of one cell is bolted to the negative strip of the next, and so on. From the closeness of the plates to each other and the magnitude of their area, the electrical resistance of the storage cell is very small, and it follows that the current it can produce is considerable. The electromotive force of the lead accumulator is about 2.1 volts, and remains very fairly constant until the cell is nearly discharged. The current at charge and discharge must not be too great, or the plates deteriorate and the cell becomes ruined. A cell with 5 positive plates and 6 negatives will usually stand a current of 40 to 50

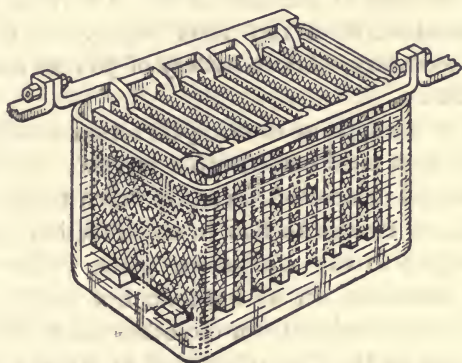

FIG. 83.—Secondary or storage cell, or accumulator.

amperes, and for a short time even greater currents. For central station work, lead accumulators have been used to a great extent, but they require careful and constant attention. They have also been used for driving electric vehicles, but have not proved a great success. Their great weight is against them, and in the rough usage they experience they rapidly deteriorate.

The latest attempt to construct a durable and efficient storage battery is due to Edison. Nickel hydrate packed into nickel tubes carried in a nickel framework constitutes the positive electrode, while finely divided iron oxide contained in pockets in a nickel steel sheet constitutes the negative electrode. Potassium hydrate in solution is the electrolyte.

The Edison accumulator has one great advantage over the lead accumulator, in that the mechanical strength of the electrodes enables it to stand rough treatment that would ruin the latter; and it may even be discharged completely, and allowed to remain discharged for a considerable period without suffering seriously, while a similar treatment would probably cause such deterioration of lead plates that they would never recover. This renders the Edison cell particularly serviceable for electric traction and for use in places where the careful attention required for the lead accumulator is unattainable. As a set off against this, there is the low voltage of the Edison cell, 1·2 volts, so that for the maintenance of a 100 volts supply, 84 Edison cells would be necessary, while a battery of 50 lead accumulators would suffice.

There is one type of electrolytic action which should be mentioned as it is of considerable service. An aluminium plate immersed in an electrolyte, of which there are many, will only allow current to flow in one direction, that is from the electrolyte to the aluminium plate. The aluminium plate can therefore act as kathode but refuses to act as anode. Using a lead plate for the other electrode interposes no restriction to the flow of current in either direction, so that if one electrode be of aluminium and the other of lead, a cell is obtained which allows the current to flow in one direction only; such an arrangement is really a valve, and it is called the **Nodon valve**. Such a valve may be used to enable accumulators to be charged by means of an alternating current; for on putting the Nodon valve in the circuit, only the half-cycle of current in one direction passes, the other is suppressed. By an arrangement of two or more Nodon valves it is possible to arrange that each half-cycle is employed. The Nodon valve is much less expensive than a motor-generator for converting alternating into continuous current for the charging of accumulators, since the fluctuations of current are of no disadvantage in this case, provided that the current is always in the same direction.

CHAPTER X

ELECTROMAGNETIC THEORY AND WIRELESS TELEGRAPHY

PERHAPS the most difficult branch of science to understand without mathematical knowledge is that which usually goes under the name of "electromagnetics" or "the electromagnetic theory." And yet the foundations were laid more particularly by two men who were not mathematicians, Faraday in England, and Joseph Henry in America, in the early part of the last century. The discovery by Oersted of the magnetic field accompanying an electric current, may be looked upon as the origin of the electromagnetic theory. This was soon followed by the work of Ampère, in which the magnetic fields for all arrangements of current circuit were given in exact and mathematical form. But the phenomena associated with changing currents and magnetic fields were still unravelled. In Chapter III the contribution of Faraday to the electromagnetic theory has been outlined, but it is necessary to consider a little more in detail the advance in knowledge which he made. He was a particularly clear thinker and was not satisfied with any explanation of natural phenomena which was founded upon the doctrine of "action at a distance." Up to Faraday's time, the laws governing the gravitational attraction between bodies, the forces between electric charges and between magnetic poles had been determined with considerable precision, but no one had advanced beyond the position of considering that bodies affect each other when situated at a

distance apart. The law of force in these cases is that of the inverse square of the distance. That is, if two bodies, electric charges, or magnetic poles, are situated a certain distance apart and exert a certain force upon each other, then on doubling their distance apart, the force between them becomes reduced to one-quarter of its previous value. When the distance is increased to three times its original value, the force is reduced to one-ninth, and so on. This law of inverse squares supplies a means of calculating the

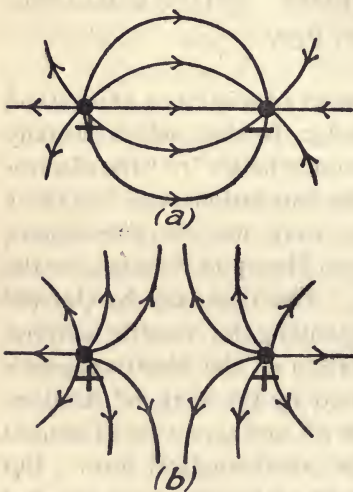

FIG. 84.—Electric lines of force due to two charges.

force under an infinite variety of conditions, but it gives no clue to the reason for the forces. That two bodies between which there is no material communication can influence each other is inconceivable, and this gap in our knowledge led Faraday to consider the space around an electric charge, or a magnetic pole, with close attention. The arrangement taken up by iron filings sprinkled on a piece of paper held near a magnet suggested the idea of lines running from

pole to pole, which lines he called magnetic lines of force. A very simple calculation will show that there are lines of force near electrical charges, for on placing a positive charge of electricity at any point, the actual force on it can be calculated, if the position of other charges is known, and the path it would follow is given by the lines of force between a positive and a negative pole in Fig. 84 (a) and for two positive poles in Fig. 84 (b). To many people these electrical lines of force are merely mathematical lines which serve to map out space in such a way that the force

on an isolated positive charge is indicated, just as lines of latitude and longitude are useful mathematical ideas for locating positions and directions. But to Faraday they were something more; they indicated some kind of strain in the medium in which these charges are situated. It is difficult to gain a clear idea of the actuality of the lines of force, but consider for a moment two bodies buried in a slab of india-rubber, and that the bodies are in some way pulled apart. Obviously the india-rubber between the bodies is stretched, and its tendency to recover its original condition pulls the two bodies together; thus the bodies behave as though they attracted each other. Although this idea is very crude, it is helpful in enabling one to realise that the force between two bodies may be due to a state of strain in the medium in which they are imbedded, and the lines in Fig. 84 indicate the directions of the strain. The force between two charges of electricity is just such as would be produced by the lines of force tending to contract. As the lines always arise on a positive and end on a negative charge, the tendency to contract would pull these charges together. But if the lines tend to contract, they would also push each other laterally, so that the repulsion between two charges of a like kind would be accounted for in Fig. 84 (*b*). Faraday was so endued with the conception of lines of force in the medium that he came to look upon the charge as merely the origin of the lines, and having no physical existence apart from them. This idea is a most fruitful one and placed Faraday far ahead of his contemporaries in many respects.

The great step forward made by Faraday was thus the concentration of our attention upon the medium, rather than upon the electrical charges, and the next great advance was made by James Clerk Maxwell, who represented the conditions of such an electromagnetic field in mathematical form. The comparatively simple equations derived by Maxwell are the expression of two laws, one due to Gauss and the other due to Faraday. Gauss's law relates to the

total effect in the space surrounding an electrical charge, or a magnetic pole, and may be rendered into a simple form by saying that a given quantity of charge gives rise to a fixed number of lines of force or, more strictly speaking, lines of induction. The distinction between lines of force and lines of induction cannot be explained here, but it may be mentioned that in empty space, and approximately in air, there is no distinction between the two. On the other hand, Faraday's law relates to the electromotive force in a circuit when the number of magnetic lines of force threaded through the circuit is changing. It is impossible in a book of this type to give an adequate account of Maxwell's equations; they may be found in works on mathematical electricity, but it should be remembered that, to this day, they are held to give a most complete representation of the effects occurring in an electromagnetic field.

There is no doubt that the most important deduction from Maxwell's equations, made by himself, is that if any change occurs in the state of an electric field, at any place, this change will cause a disturbance which travels outwards in all directions from the place, with a velocity which can be calculated from the electric and magnetic properties of the medium through which it is travelling. Although such motion had not been observed in Maxwell's time (1865), still the measurements made indicated that the velocity should be 300,000 kilometres per second, which is also the velocity that had been measured for light. This suggestive fact made it almost certain that light consisted of waves of electromagnetic change, since the coincidence in the values of the velocities of the two effects was hardly conceivable under any other conditions. What made Maxwell's discovery more significant was the fact that light was known to consist of waves; but there were many theories as to the nature of the medium in which the waves were taking place. For waves consist in motion, and for motion there must be something to move. No known material had mechanical properties such that waves in it would travel

with the prodigious velocity of light. And, moreover, light travels best through "empty space" or space free from matter such as we know it, and consequently it was supposed that all space was filled with "æther," which was so light but so rigid that the waves in it had a velocity of 300,000 kilometres per second. Many theories as to the nature of this æther, known as elastic solid theories, were formulated, but each theory encountered great difficulties in accounting for the known properties of waves of light. Most of these difficulties disappear when light is acknowledged to be an electromagnetic wave, which fact alone was of great assistance in furthering the belief in the validity of Maxwell's electromagnetic theory of light. It must not be thought that the phenomena of the electrical field are now thoroughly explained, in the ordinary sense of the term; that is, that the electrical field and its changes, which constitute light, can be accounted for in terms of effects which appeal to our senses. Such an explanation may very well be impossible, because we have no sense which indicates directly to us the presence of electricity. The phenomenon to which we give the name "electricity," is only deduced from our observations of movements produced in ordinary matter; for example, the attraction of light bodies by amber which has been rubbed, by the arrangement of iron filings round a wire, and by the innumerable other movements which have been mentioned in the earlier chapters. But a theory must be judged by its ability, not only to account for observed phenomena, but to predict others, and our belief in what we call electricity led not only to the prediction of the possibility of electromagnetic waves by Maxwell, but also proved the guiding principle which led to the unravelling of the mysteries of X-rays and radioactive changes. Although electricity cannot appeal directly to our senses, there is probably no more deeply seated belief in existence than that which leads us to look upon ordinary material effects as due to the electrical foundation of matter.

In order to understand the later developments of

electrical theory we must now turn to a mathematical discussion due to Lord Kelvin (then Professor Wm. Thomson) in 1853, and attempt to explain it without the aid of mathematics. We have seen that a positively charged body attracts a negatively charged body, and we have explained it by the attraction existing between positive and negative electricity.

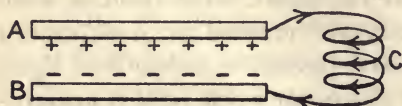

FIG. 85.—Charged plates of a condenser connected by a wire.

If now two sheets of metal A and B (Fig. 85) are insulated and A is charged with positive and B with negative electricity, the charges will remain on the plates, since there is no path for their escape. Such an arrangement is called an **electrical condenser**, and if the plates are of considerable extent and are very close together, large quantities of electricity may be accumulated upon them. Although the charges are attracting each other they remain apart, because there is no conducting path along which they can flow in order to combine. But if A and B are connected by a wire, the charges flow along the wire, will combine and so disappear.

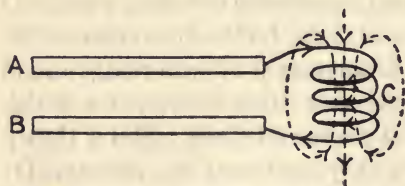

FIG. 86.—Conductor at the moment when discharge is complete, but current is flowing in wire connection.

If the wire connecting them be coiled into the form shown at C, then, while the charges are flowing there is an electric current in C, in fact the motion of the charges is the current, and its direction is shown by the arrows. Now we saw on p. 19 that when there is a current in a coil, there will be a magnetic field, and its form is indicated by the dotted lines of force in Fig. 86. At the moment that the charges are just used up, the current in the coil reaches its greatest strength, and since there is no more charge on the plates, it looks at first sight as though the current must suddenly

stop. But there is the magnetic field in existence, and for the current to stop, this magnetic field must disappear. The only way for the magnetic field to disappear is for the magnetic lines of force to collapse, and in so doing they must cut the turns of the coil C, which, as was seen on p. 31, produces an electromotive force in the coil. The current therefore continues to flow, which means that positive electricity is still being driven towards the plate B and negative electricity towards the plate A. This goes on as long as there is any magnetic field, and by the time that the magnetic field has disappeared, B has become charged with positive and A with negative electricity. The state of affairs now attained is

shown in Fig. 87, and it will be seen that the condition is the same as at the start (Fig. 85) but with the

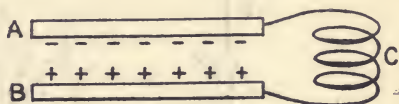

FIG. 87.—Condenser or complete reversal of charge.

charges reversed in sign. The process now starts again, the charge flowing back and producing a magnetic field in the coil, which continues the current until A is again positively and B negatively charged. The effect of the magnetic field in the coil C is therefore to cause the charges to surge backwards and forwards between the plates, in fact the motion of the electricity is **vibratory** or **oscillatory**, just as is the motion of a pendulum. In the act of drawing the bob of the pendulum aside, it is raised to a higher level. On being released it moves to its lowest position and in so doing gains velocity which causes it to mount up on the other side. Thus it continues to swing backwards and forwards. But the swings of a pendulum die away owing to friction and consequent loss of energy, so in a similar manner the electrical oscillations that occur during the discharge of a condenser die away owing to the work done in driving the current through the wire, which is therefore heated.

The oscillatory nature of the discharge of a condenser

when the current produces sufficient magnetic field, was foretold on mathematical grounds by Lord Kelvin, but it was not until Feddersen in 1857 thought of examining the spark discharge of a condenser, which had the form of a Leyden jar, by means of a rotating mirror, that the oscillations were actually detected. The jar is charged by means of an electrical machine until the difference of potential between two metal knobs A and B (Fig. 88) is so great that the air between them becomes conducting for electricity. When this condition is attained, the current passes, with formation of a bright spark. The mirror M forms an optical

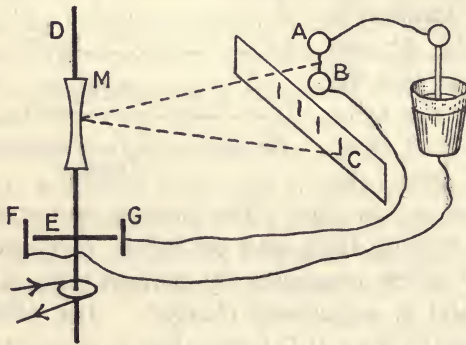

FIG. 88.—Apparatus for demonstrating the oscillatory character of the discharge of a condenser.

image of the spark on the screen C. On causing the mirror to rotate, the conducting arm E, carried on the axle D to which the mirror is attached, makes contact between F and G, thus bridging the gap in the condenser circuit at the moment when the mirror is in the proper position to form the image on the screen. If the knobs are far apart, the resistance of the circuit is so great that the discharge current does not oscillate, and even at fairly high speeds of the mirror only a single image is formed on the screen at each discharge. But on shortening the gap AB, a condition is reached at which the discharge oscillates, and there is a double image produced on the occasion of each discharge.

With shorter gaps five or six oscillations may be produced at each discharge before the spark is quenched. In this way the oscillatory discharge of a condenser, foretold by Lord Kelvin in 1853, was first shown to exist. It is now known that flashes of lightning frequently have an oscillatory character, as may be seen on taking a photograph with a moving camera, a row of several parallel images being produced.

The twenty-three years which elapsed after the publishing of Maxwell's electromagnetic theory in 1865 were not fruitful in the development of electrical knowledge, for it was not until 1888 that H. Hertz detected electromagnetic

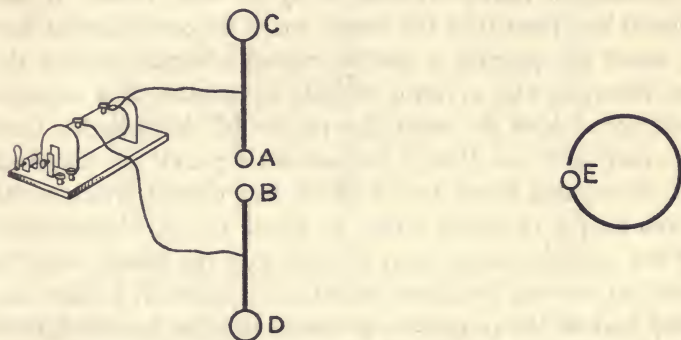

FIG. 89.—Hertz's arrangement of oscillator and detector.

waves in the space surrounding a conductor in which electric oscillations were occurring. He used many forms of oscillator, one of which is shown in Fig. 89, in which the conductor AC, consisting of two attached knobs, is jointed to one pole of an induction coil, and BD to the other pole. On causing a spark between A and B, electromagnetic waves travel outwards from the oscillator. Hertz's particular discovery consists in the detection of these waves. A ring of metal with a minute gap at E is affected by the waves; for every time a spark occurs at AB, a minute spark is seen at E, even when E is fifty or sixty feet away from AB. This discovery was a great step forward, in fact it

was the one condition required to establish the electromagnetic character of light and to open up the way to electric signalling without wires. It should not be forgotten that at about this time Sir Oliver Lodge showed that the discharges of a Leyden jar could produce discharges in a neighbouring Leyden jar of the same size, if a small gap was left in the wire connecting the coatings of the second jar. Thus Lodge discovered independently the fact that the electromagnetic waves are emitted by a Leyden jar discharging between knobs, and could produce similar oscillations in a suitable conductor upon which the waves fall. But Lodge did not give the conditions of the phenomenon nearly so completely as did Hertz. It was shown by Hertz that the waves could be concentrated into a beam by placing a curved metallic mirror behind the oscillator, as can a beam of light by means of a suitable reflector. Also the wave-like nature of the radiation from the oscillator was clearly demonstrated; and the length of the waves was found to be about five metres, whereas the wave-length of light waves is about 0·00006 centimetre. Other experimenters soon showed that the waves could be bent on passing from one substance to another, in fact that they had all the properties of waves of light, including their prodigious velocity of 300,000,000 metres per second.

Before proceeding to the modern application of the Hertzian waves it is necessary to gain a clearer idea of their nature. There are several ways of representing them, the most powerful of which is, of course, that of mathematical analysis; but the use of Faraday's idea of lines of force has proved of such great help that many writers speak of the waves in terms of lines of force. One difficulty should be mentioned at the start: lines cannot completely fill space, so that gaps will be left between them, and it seems as though the effect of one line upon another must be excited across this empty space. The difficulty is removed by considering the mapping out of space to take place by means of **tubes of force** which actually touch each

other and so fill the whole of space, leaving no gaps, in a manner somewhat similar to the cells in a honeycomb. Instead of drawing the tubes, it is convenient to draw a line down the axis of each tube to represent it. The whole convention is one of convenience in considering the effects around electric charges, and it is of no consequence what convention is adopted, provided that it enables us to follow the electrical conditions occurring in electrical fields. With this explanation, we shall now decide on employing electrical lines of force in our discussion.

Consider two wires ending in knobs A and B in Fig. 90 (i). If the upper rod is charged with negative electricity

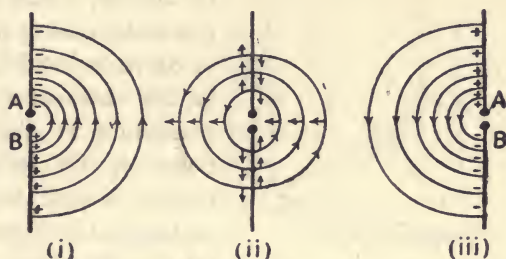

FIG. 90.—Electric lines of force surrounding an oscillator.

and the lower rod with positive electricity, the lines of force are as shown and are at rest. For the sake of clearness, only the lines on one side are shown; in reality the whole space round the conductors is filled with lines. If now the air gap between A and B suddenly becomes conducting for electricity, the lines of force begin to contract, because the positive and negative charges can flow together across the conducting bridge, and it will be seen that every part of each line is travelling towards the gap, and is moving perpendicularly to itself. At the same time, the motion of the positive charge upwards and the negative charge downwards is really an electric current flowing upwards through the conductors, and a current such as this is surrounded by a magnetic field, of the form shown in Fig. 5, p. 13. Hence we conclude that electric lines of force in motion constitute a

magnetic field, and the direction of the magnetic field is at right angles to the electric lines of force and to their direction of motion. The three effects are related to each other like the three sides of a cube, as shown in Fig. 91. This conception of a magnetic field, as the motion of an electric field at right angles to itself, has been developed by Sir Joseph J. Thomson, and has been of great service in the representation of electromagnetic waves. It supplies the one property of the electric lines of force which was wanting in Faraday's original idea, namely, momentum when in

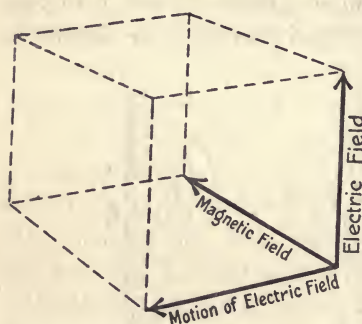

FIG. 91.—Relation between the directions of magnetic and electric fields in an electric wave.

motion. Momentum is a property of ordinary matter in motion, which prevents the motion being increased or decreased suddenly. It is the momentum of the pendulum at the lowest point of its swing that carries it past this point and causes it to mount up on the other side. So the lines of force as seen in Fig. 90 (ii) have momentum

which carries them through the gap so that they spread out on the other side until their tendency to contract brings them again to rest, as in Fig. 90 (iii). In (ii) they are just half-way; the electric current is at its greatest value, and the position of the electric lines of force shows that the charge is at this instant zero; but the lines are in motion and their momentum will carry them on until condition (iii) is reached, when it will be seen that the charges are exactly reversed from their original condition (i). If the air gap is still conducting, the process now starts again in the reverse direction, and after another similar oscillation the state of (i) is reached again. This oscillatory process is identical with that occurring in the oscillatory discharge of a condenser, worked out by Lord Kelvin (p. 150), but it has

been explained from a different point of view, which is more suitable for following the radiation which occurs in wireless telegraphy.

The conductors of Fig. 90 correspond to the Hertz oscillator, but it is not yet evident why radiation should occur. In order to follow the process of radiation, consider Fig. 92 (i), in which the more distant lines of force are shown, although only half the complete diagram is given, as in the previous case, for the prevention of confusion. The shorter lines such as ABC, EFG, will pass through the air gap as before, but the ends L and N of the more distant lines will arrive at the gap before the more distant part M.

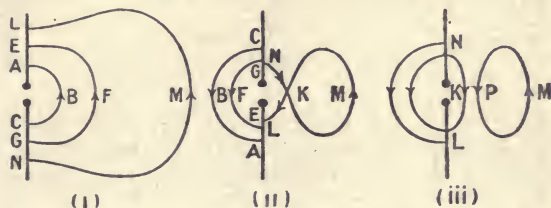

FIG. 92.—Electric lines of force forming radiation loops.

Remember that every line has momentum which carries it onwards, always in a direction at right angles to the line itself, and it will be seen that the shape of the line LMN will become LKMN, as seen in Fig. 92 (ii). Now this, for reasons which cannot here be given, is an unstable condition, and the line breaks into a loop PM, and a short line NKL seen in Fig. 92 (iii), and the loop PM is pushed outwards by the neighbouring lines. Once in motion, it continues so by virtue of its momentum. A more complete representation of the formation of the electric lines of force given out from a Hertz oscillator is given in Fig. 93, where eight stages of one half-oscillation are shown. It will be seen that between *a* and *c* (Fig. 93 (viii)) the direction of the electric field is downwards, and from *c* to *d* it is upwards.

By means of the Hertz oscillator, waves can be produced which he detected over distances up to 50 or 60 feet, and

there is no doubt that with the sensitive detectors now in use these waves might be detected over many times that distance. But really long-distance transmission was rendered possible by the use of greatly extended oscillators by Sigr. G. Marconi in 1898, who employed a mast or vertical wire, called an aerial, as an oscillator, the spark taking place between knobs as before, but one attached to the aerial and the other to the ground. It is thus clear that only half the diagram of Fig. 93 is applicable to this case, and the form

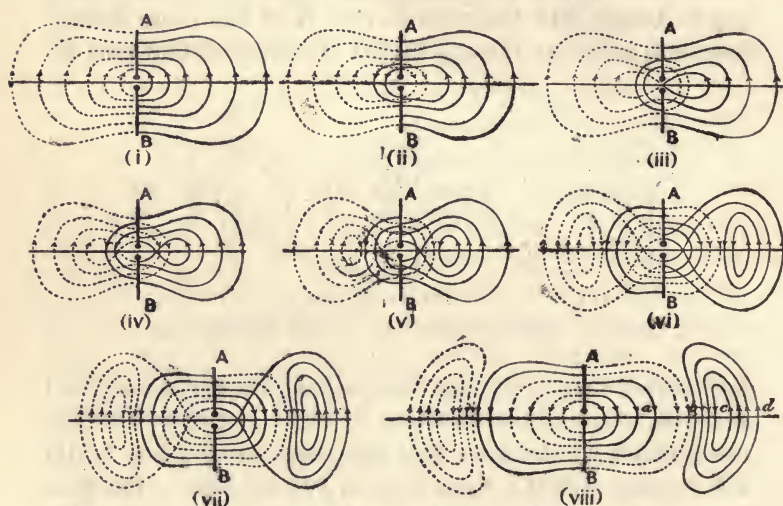

FIG. 93.—Electric lines of force near an oscillator during radiation.

of the lines of force will be more as shown in Fig. 94. The diagram is not drawn to scale; the upper layer of the atmosphere FG , which is more conducting than the rest, is shown, and should be at a much greater elevation than is indicated. Nevertheless, the diagram shows the loops travelling outwards, the field at a , c , and e , etc., being in one direction and at the intervening positions b , d , etc., in the reverse direction. At a distance from the aerial A the waves are nearly vertical, and are of course travelling outwards with the velocity of light, 300,000,000 metres per

second. The frequency of oscillation commonly used in wireless telegraphy varies from 2400 to 1,000,000 oscillations per second, which shows that the length of wave varies between $\frac{3000000000}{2400} = 125,000$ metres and $\frac{3000000000}{1000000} = 300$ metres. Accompanying the electrical lines of force there will be, of course, magnetic lines of force at right angles to the electric lines and to the direction of travel of the waves. The magnetic lines are most closely crowded together at *a, b, c*, etc. (Fig. 94), and the magnetic field is zero between them. Also the magnetic lines of force travel with the same speed as the electric lines. The magnetic lines of force cannot be shown conveniently in the same diagram as the electric lines, being at right angles to them, and they are consequently left out of

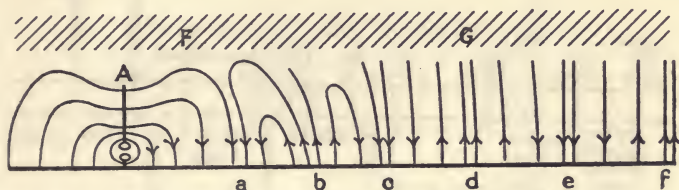

FIG. 94.—Electromagnetic waves proceeding outwards from an aerial.

the figure. Generally we shall omit mention of them, but it must be always borne in mind that whenever the electric lines are travelling, they are always accompanied by the magnetic lines. The very condition of motion of the electric lines is that there should always be magnetic lines at right angles to them, and the velocity of motion in the empty space (or in air) is then 300,000 kilometres per second, or the velocity of light.

It is interesting to review the electromagnetic radiations with which we are acquainted, and to realize how they form a long series, from the lowest frequency to the highest. In the case of sound or air waves, the lowest note that the ear can detect has a frequency of about 10 oscillations per second and the highest about 25,000 per second, comprising in all just over 11 octaves. But when

we turn to electromagnetic waves we find a vastly greater range, although, of course, the eye is only sensitive to the waves comprising a very small portion of this range, extending over about one "octave," to borrow an expression from music. Nevertheless, the visual rays are of by far the greatest importance, and the study of them has given us the key to the whole sequence. It was Sir Isaac Newton who first examined white light and showed it to be a mixture of different rays, by passing it through a glass prism. The prism bends the differently coloured rays to different extents and so separates them. The appearance of the spectrum of white light is well known, the arrange-

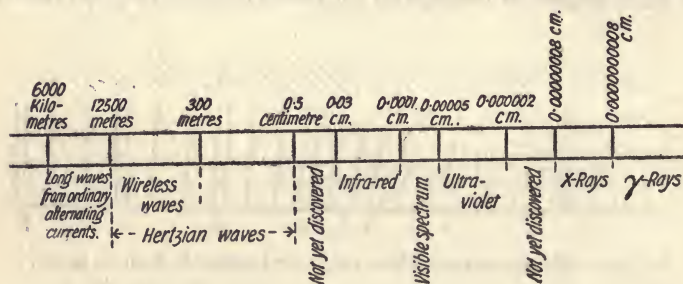

FIG. 95.—Diagram showing the various electromagnetic waves.

ment of colours being the same as that in the rainbow. The extreme red rays are bent least by the prism, and have a wave-length of about 0.0001 of a centimetre, while the extreme violet rays are bent most and have a wave-length of about 0.00005 of a centimetre. Between these the various colours, orange, yellow, green, and blue, are ranged. Photography has revealed the presence of other rays beyond the violet, to which the eye is not sensitive, called the ultra-violet, or actinic rays, and the study of heat has proved the existence of still other rays beyond the red, the infra-red rays whose heating effect alone can be detected. But far beyond the infra-red, the ordinary electromagnetic waves come into the series, and beyond the ultra-violet are the X-rays and γ-rays. The diagram of Fig. 95 makes an

attempt to draw the spectrum as it would be if all the known electromagnetic rays could be arranged side by side as in the ordinary light spectrum. Of course the range of wave-length is so great that one single diagram drawn to true scale could not give them all; their true positions are only indicated by the values of their wave-lengths. The whole range comprises about 60 octaves, and with the exception of two small gaps, one just beyond the infra-red and the other just beyond the ultra-violet, all these waves have been detected, and in many cases used for important purposes. It is a significant fact that one of the most

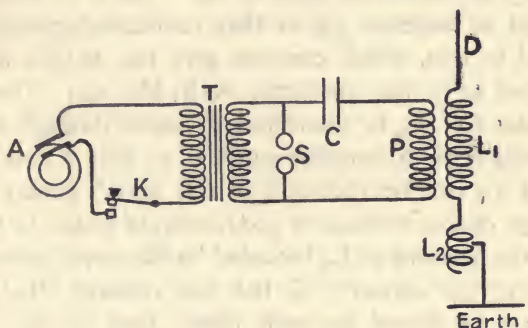

FIG. 96.—Method of exciting oscillations in an aerial.

sensitive detectors, if not the most sensitive, is the eye itself, and that of all the rays emitted by the sun and constituting ordinary sunlight, the greatest intensity of the rays occurs for just those rays to which the eye is sensitive. Thus the eye has been developed to make use of the rays which the sun emits most copiously.

The earliest method of producing electromagnetic waves for the purposes of wireless telegraphy consisted in causing sparks between knobs, by means of an induction coil, as in Fig. 89. This method has, however, many disadvantages and has been replaced by several others, of which the next type in order of development is shown in Fig. 96, which represents a type used for many years. An

alternating-current dynamo A and transformer T produce a sufficiently high electromotive force to produce sparking at the knobs S whenever the key K is depressed. An induction coil may be used in place of the alternator and transformer when only small power is to be transmitted; but for long-distance telegraphy, when considerable horsepower is required, the alternator is essential. At each spark, electric oscillations are set up in the circuit SCP, containing the condenser C, and coil P. A second coil L_1 is wound upon P, or is very close to it, so that P and L_1 act as a transformer, the oscillatory current in P causing an oscillatory electromotive force in L_1 . L_1 is in series with the aerial or antenna D, so that oscillating currents are produced in this, which currents give rise to the radiated waves just as in the conductor A in Fig. 94. The lower end of the coil L_1 is connected to earth through another coil L_2 which has a movable contact, so that a part or the whole of L_2 can be included in the aerial circuit. The advantage of this method of production of waves is, that by varying the amount of L_2 included in the aerial circuit, and by varying the capacity C, the two circuits DL_1L_2 , and SCP may be *tuned* to each other, that is, the natural frequency of the oscillations in the two may be made the same. When this tuning is effected, the oscillations in the aerial are much more powerful than would otherwise be the case. This process of tuning may best be understood by considering a corresponding case in the production of sound waves. If a whistle or tuning-fork be held near the mouth of a hollow vessel, or organ pipe, the air in the pipe will be set in violent vibration and will "speak" when the natural frequency of vibration, or "pitch," of the whistle or tuning-fork is the same as that of the organ pipe. But when the tuning is not perfect, the pipe is silent. There is another advantage in tuning to a suitable frequency in the case of wireless telegraphy, for the waves emitted by different stations may be given different frequencies, so that at the receiving station, the receiving apparatus may be

similarly tuned, and the waves from only one transmitting station at a time will affect the instruments, such tuning being termed *syntony*. The confusion that would arise when many stations are emitting waves, if all these waves affected all the receiving stations, may be imagined.

The oscillations and waves produced in the manner just described are heavily *damped*, that is, they die out after a few oscillations. Such an oscillation may be represented in a diagram as in Fig. 97. Thus, the curve ABCDE represents a heavily damped oscillation, and it will be understood that after the point C is reached, the current is so

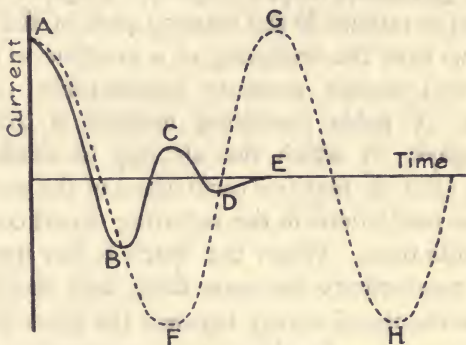

FIG. 97.—Damped and undamped oscillations.

small that it is ineffective in producing radiation. The curve AFGH represents an oscillation which is undamped, and we shall see later how such oscillations may be produced. A common frequency of oscillation occurring in wireless practice is about 100,000 per second, and if the damping is so great that after 10 oscillations there is no radiation, then after a lapse of $\frac{1}{100000}$ second the radiation has ceased, and will not start again until the next spark occurs. There may be 500 sparks per second, which would mean that in the whole of one second, radiation is only going on for $500 \times \frac{1}{100000}$, that is $\frac{1}{200}$ of a second, owing to the comparatively long intervals between successive sparks. This means that the radiation can never, under these

conditions, be very efficient, since for only $\frac{1}{20}$ of the time is radiation going on. There have been many methods devised for obtaining continuous radiations, and since these require undamped oscillations, the production of continuous or undamped oscillations is an important problem. An obvious solution of the difficulty is to design an alternator of the required frequency. This has been successfully performed, although it presents great difficulties, owing to the high frequency required. R. Goldshmidt, E. F. W. Alexanderson, and others have tackled the problem in this way, and alternators producing 100,000 cycles per second have been produced, which required a speed of 20,000 revolutions per minute in the rotating part of the machine. It is obvious that the designing of a machine to run safely at such high speeds presents considerable mechanical difficulties. A more promising method is that of the **quenched spark**, in which the air gap is rendered non-conducting after the first few oscillations of the current. In this case the oscillations in the radiating circuit continue for a considerable time. When the spark is not quenched, it retains its conductivity for some time, and there is a recurring interchange of energy between the spark circuit and the aerial circuit. At the instant represented by A in Fig. 98 (a), the energy of oscillation has been entirely transferred to the aerial circuit, while at B the energy has been retransferred to the spark circuit. This interchange occurs many times; but if the spark is prevented from recurring after the point A has been reached, the oscillation in the aerial circuit, as shown in Fig. 98 (b), continues for some time, and the waves radiated are much less damped, and so continue for a much longer time than in the case of a heavily damped wave. This effect was discovered by M. Wien in 1906. He employed a spark gap consisting of parallel copper plates about a quarter of a millimetre apart. The high conductivity for heat of copper, together with its massive form, renders the cooling of the gap so rapid that when once the spark has ceased, the temperature falls so

rapidly that the spark will only with difficulty be re-established. Other methods of quenching the spark have been employed, amongst which may be noticed that of Professor Fleming, in which two steel discs are separated by a thin layer of paraffin oil, one of the discs being maintained in rapid rotation.

One of the most interesting of the methods of pro-

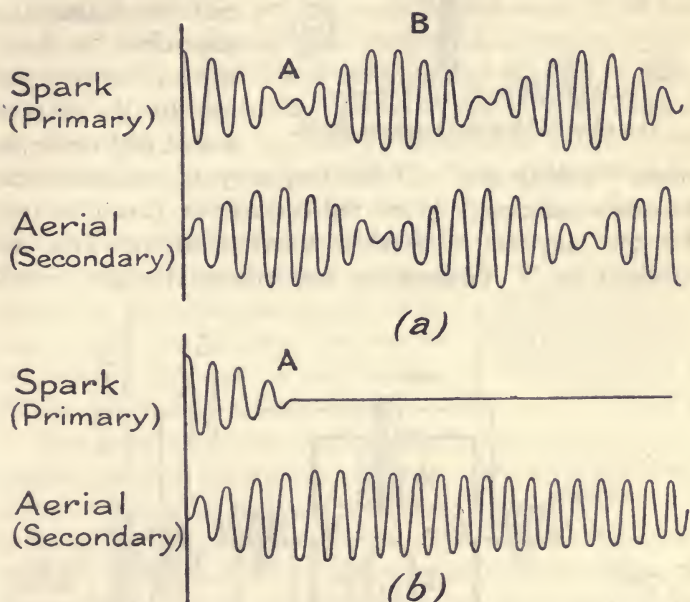

FIG. 98.—Waves from aerial with (a) unquenched spark, and (b) quenched spark.

ducing electrical oscillations was described by Elihu Thomson in 1892, and further developed by W. Duddell in 1900. It makes use of a peculiar property of the electric arc. If an ordinary arc A between carbons (Fig. 99) be maintained by a battery B, the current passing through coils E and F, and a circuit LC, consisting of a condenser C and a coil of wire L, be connected to the two sides of the arc, as shown, then it will be found that the ordinary hissing

of the arc becomes quite regular, taking the form of a musical note. The reason for this is, that electrical oscillations occur in the condenser circuit, so that alternating currents flow through the arc. When the current flows in

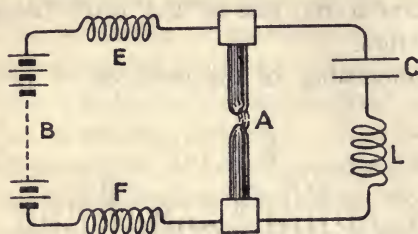

FIG. 99.—Duddell oscillating arc circuit.

one direction it increases that in the opposite direction it diminishes it, and these alterations in intensity of the arc give rise to the musical sound, and hence the name "singing arc." If the frequency of oscillation can be made sufficiently great, the currents in L can be used for the purposes of wireless communication. This was attained by V. Poulsen by constructing the arc circuits

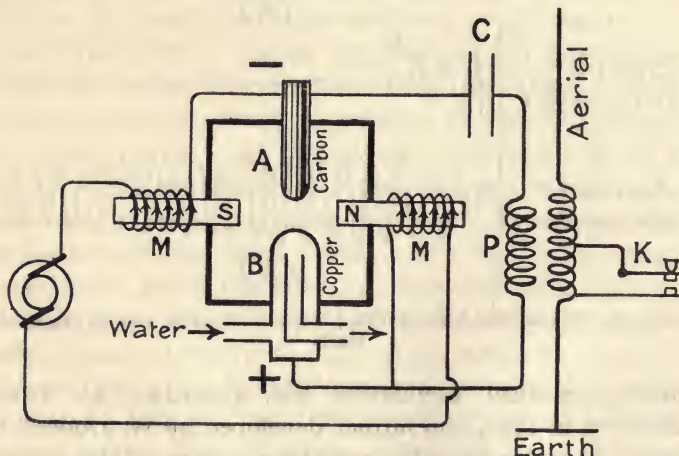

FIG. 100.—Poulsen arc circuit for the production of electric oscillations.

of a particular form. The arc is produced between a carbon rod A (Fig. 100) and a copper electrode B, which is hollow and cooled by a stream of water flowing through it. The arc is enclosed in a chamber which is filled with

some gas, such as hydrogen or coal gas; any gas which does not contain oxygen is effective. In addition, two electro-magnets MM are fed by the main current and tend to quench the arc by displacing it laterally. With this arrangement Poulsen has succeeded in producing powerful oscillatory currents of undamped type in the circuit CP, which by means of the transforming coils P produce oscillations in the aerial. The frequencies 500,000 to 1,000,000 may be produced by varying suitably the capacity C and the coil P. The signalling is performed by means of the Morse key K, which short-circuits part of the coil in series with the aerial, so throwing the aerial out of tune, without interrupting the arc; or else by employing a key which substitutes a dummy non-radiating circuit for the aerial for the times corresponding to the spaces between the dashes and dots of the Morse code. There is still another method of producing undamped oscillations, but this involves the use of the triode tube, and its explanation will be deferred for a short space.

The development of wireless telegraphy has been rendered possible on account of the discovery of sensitive methods of detecting electrical oscillations. The first detectors were merely circuits, in some cases similar to the oscillating circuit, in which the waves falling upon them set up oscillatory currents of sufficient strength to cause a minute spark at a gap in the circuit. The tuned Leyden jar of Lodge, and the loop of wire of Hertz (E, Fig. 89), are of this type. Professor A. Righi used a series of resonators consisting of thin strips of silver, made by scratching the silver from a silver plate-glass mirror, the required strips being left on the glass. They are made of various lengths, and each strip has a gap at its middle, AB (Fig. 101). When the waves have the same frequency as the natural frequency of any one strip, oscillatory currents

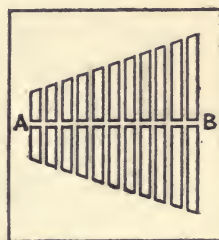

FIG. 101.—Righi wave-detector.

are set up in the strip, and a minute spark can be seen at the gap. The effect is similar to that which occurs when electromagnetic waves fall on an aerial, although, of course, much more sensitive detectors than a mere spark gap are now used. If the waves are represented by their electric lines of force CDEF (Fig. 102) travelling from left to right towards a resonator AB; while the part of the field represented by E is passing AB, there is an electric field directed upwards and a current will be caused to flow upwards in the conductors AB. Similarly, when D or F is passing, the field and current will be downwards; and if the natural period of oscillation for the circuit AB is the same as that of the oncoming waves, each wave, as it arrives,

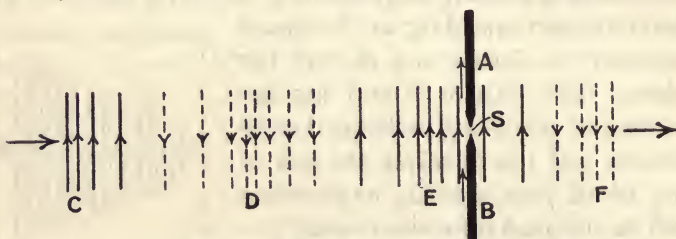

FIG. 102.—Electromagnetic waves producing oscillation in a detector.

tends to strengthen the current in A and B. It follows that after a few waves have passed, the surging of electric charge up and down AB may be sufficiently violent for the gap S to be jumped, with formation of a spark. This tuning, or resonance, is an important factor in sensitive receiving in wireless telegraphy.

A very important step in the detection of electromagnetic waves was made by E. Branly in 1890. He used a property of metallic contacts, which had been known for some time, but is not even now understood completely. When electric waves fall upon a loose mass of metallic filings the electric resistance of the mass falls considerably, but is rapidly restored to its original amount by mechanical disturbance such as tapping. Such an arrangement was

named **coherer** by Sir Oliver Lodge, and the name has come into general use. One form of Branly coherer is shown in Fig. 103 (*a*), in which a quantity of iron filings *A*, contained in a glass tube *B*, can be slightly compressed by two metallic plugs *C* and *D*, which also act as terminals. On connecting a battery to *C* and *D*, with a detector or galvanometer in the circuit, it is found that when electric waves from the discharge of a Leyden jar through a coil of wire fall upon the coherer, the current is increased to a considerable extent owing to the drop in electrical resistance of the mass of iron filings. A slight tap to the tube will restore the current to its original value. Many metals were used, the best effect being obtained with those which are moderately oxidizable,

such as iron, nickel, and silver. Marconi, in 1896, brought the coherer to its most efficient form by using a mixture of nickel and silver filings between silver plugs. The filings *A* are placed

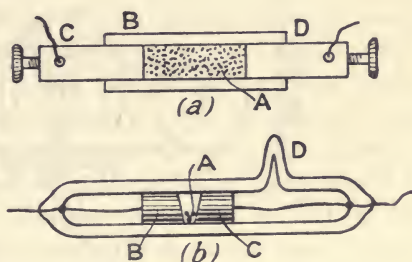

FIG. 103.—Coherers.

between the tips of two silver plugs *B* and *C* (Fig. 103 (*b*)), contained in a glass tube which is exhausted of air and sealed at *D*. The coherer is placed in the aerial circuit, and the small oscillatory currents in it cause a drop in electric resistance of the filings sufficiently to enable the current from a cell through it to close a relay (p. 94); a stronger local current then actuates an inking recorder (p. 94). At the same time the relay, or in some cases the tapper, of an electric bell is allowed to strike the coherer, and so restore it to its original condition. It is then ready to receive the next signal.

Amongst the further developments in receiving apparatus, the magnetic detector is of special importance, owing to the

wide use to which it was put. The effect of the current from a discharging Leyden jar, upon steel needles had for a long time been puzzling, and different workers had failed to find any constant effect. Sometimes the steel was magnetized in one direction, sometimes in the other, and sometimes it was not magnetized at all. To Sir Ernest Rutherford is due the credit of making an important discovery. A piece of steel, situated inside a solenoid, and magnetized to saturation, is found to be only partially magnetized after a rapidly oscillating current has been passed through the solenoid. Rutherford showed that in this way electromagnetic waves producing an oscillatory

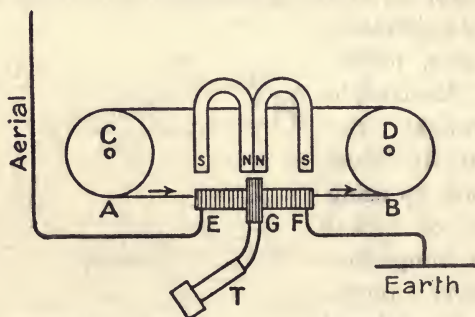

FIG. 104.—Marconi magnetic detector.

current in the solenoid caused a reduction in the magnetization of a steel wire. This arrangement was modified by G. Marconi, who devised a continuously-acting wave detector, which depended for its action upon the effect of rapid electric oscillations upon magnetization. A continuous cable of silk-covered iron wire AB (Fig. 104) passes over two pulleys C and D, which are in rotation, so that the wire between A and B passes under the four poles S, N, N, S of two horse-shoe magnets. Thus the wire is strongly magnetized in one direction as it passes under the first pair of poles, and in the reverse direction as it passes under the second pair. Whilst in these fields the iron wire passes through a solenoid EF, through which the current produced in the

aerial by the electromagnetic waves is passing. The exact effect of the oscillations upon the magnetization is still open to some doubt, but it is certain that it produces an alteration in the magnetic condition of the wire, and that this alteration, whatever its character, produces induced currents in the coil G wound over the central part of the solenoid. This, in turn, produces current in the telephone receiver T, and a sound will be heard on placing the receiver to the ear. Thus on the arrival of each train of waves at the aerial, a click will be heard in the telephone receiver, and on the stoppage of the waves, the horse-shoe magnets will restore the original magnetic condition of the iron wire, and another click will be heard. Owing to the great sensitiveness of the telephone, comparatively feeble oscillations can be detected in this way, and the passage of each train of waves produced by each discharge or spark at the sending station causes a sound in the telephone, which sounds build up into a continuous hum, interrupted or started by the opening or closing of the Morse key in the actuating circuit. By means of the Morse key, long and short sounds may be produced in the telephone, corresponding to the dashes and dots of the Morse code. The telephone cannot, under any circumstances, be affected directly by the oscillations in the aerial circuit produced by the electromagnetic waves; for the frequency of these waves varies between 2400 and 1,000,000 per second, while the greatest frequency which the ear can detect is about 22,000 per second. This is a very shrill note, and is beyond the limits of hearing of many people. Another and even lower limit in frequency imposed by the use of the telephone is due to the fact that the diaphragm of the receiver itself cannot be caused to vibrate very rapidly. The frequency of vibration employed in ordinary speech lies chiefly between 500 and 1000 vibrations per second, the latter being a fairly high pitch. It is thus clear that the rapid oscillations used in radio-telegraphy cannot cause the diaphragm to vibrate, and even if they could, the ear would be incapable of detecting such vibrations.

Nevertheless the direct effect upon the telephone of the waves has been largely employed for the receiving of wireless signals. Consider the wave trains A, B, C, and D (Fig. 105 (a)). The separate oscillations of each train are, as we have just seen, far too rapid to affect the telephone. But suppose that the lower halves of all the waves could be suppressed, then we should have the state of affairs shown in Fig. 105 (b). The upper halves of the waves A follow each other so rapidly that their effects upon the diaphragm of the telephone, being all in the same direction, are added together, and the wave train A gives one impulse upon the

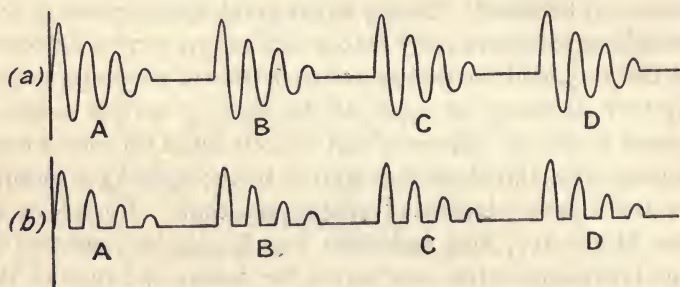

FIG. 105.—“Rectification” of waves.

diaphragm and results in a single impulse being heard. Similarly for B, C, D, etc., and if these impulses succeed each other sufficiently rapidly they build up into a continuous note of definite pitch when the receiver is applied to the ear. The frequency of this note is the number of trains of waves A, B, C, D, etc., arriving at the aerial in a second, and not that of the separate waves in one train. The frequency of the trains of waves is fixed by the rapidity of the make and break of the sending current circuit.

Several systems have been devised to make use of the heating effect of the oscillatory current as it passes through a very fine wire for the purpose of reception, but the extreme sensitiveness of the telephone, and the readiness with which signals in the telephone are adapted to the Morse

code has resulted in the neglect of other methods of reception.

Many successful attempts have been made for the suppression of one-half of the oscillations, or as it is sometimes called **rectification**, to enable the electric waves to be detected by the telephone. This method requires some form of valve, or **rectifier**, which will allow current to pass in one direction only, or at any rate, to pass more freely in one direction than in the other. The **crystal detector** employed is a rectifier of this type. It usually consists of a crystal of some kind pressing against a metallic surface, the most common type being a crystal of carborundum pressing against a surface of steel, or a crystal of the mineral zincite

(oxide of zinc) against one of chalcopyrite (sulphides of copper and iron). The crystal A (Fig. 106) is fixed in a mass of solder or fusible metal, and is maintained in

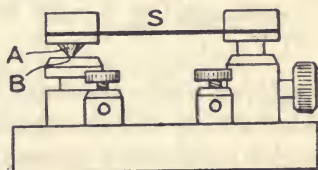

FIG. 106.—Crystal detector.

contact with the metal surface B by the flat spring S. A small electromotive force tending to drive an electric current across the point of contact of the crystal and metal will produce a current whose value depends upon the direction in which the electromotive force acts, so that an oscillatory electromotive force such as is produced when electromagnetic waves fall upon the aerial, will produce more current when directed one way across the crystal contact than in the reverse direction. Thus the halves of the waves (Fig. 105) are not completely suppressed, but more current flows in one direction than in the other, so that there will be a resultant current remaining in one direction which will affect the receiving telephone. In Fig. 107 a curve is drawn showing the character of the relation between electromotive force and current in the case of a carborundum-steel detector. For an alternation of electromotive force between two such points as A and B, the

amount of rectification is very small, but if the mean value of the electromotive force be OH , instead of zero, a current corresponding to DF will flow at the extreme value of one half-cycle, and current CK for the other. Thus the current

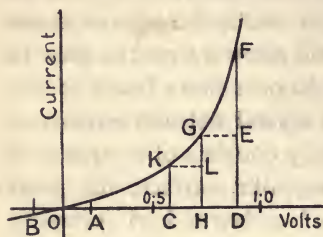

FIG. 107.—Diagram explaining "rectification" by a crystal detector.

in the telephone will oscillate about GE , being EF for one extreme and GL for the other, and the resultant current will be proportional to the difference between these two. Hence the more sharply the curve bends upwards, the more effective will be the rectification. For this reason an auxiliary battery B (Fig. 108) is

employed which maintains a current in a resistance R , provided with a movable contact, so that the average electromotive force acting across the crystal contact can be varied until the best condition for rectification is found. This is appreciated by the signals then being heard most loudly in the telephone T .

An alternative to the crystal detector is the thermionic valve of Prof. J. A. Fleming (1904), which makes use of an earlier discovery of Edison, that in a highly exhausted incandescent lamp an electric current will flow from a third conductor to the filament, but not in the reverse

direction. One arrangement for the receiving of wireless signals, as given by Prof. Fleming, is shown in Fig. 109. The battery B maintains the filament F of the glow lamp, either carbon or tungsten, in incandescence, while the adjustable

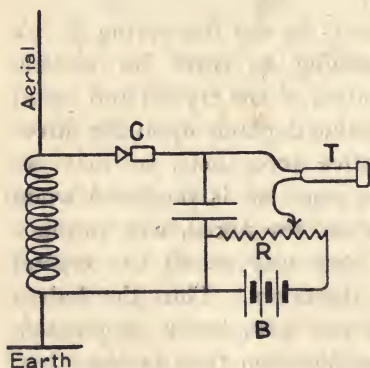

FIG. 108.—Receiving by means of a crystal detector.

resistance R_1 can be varied until the proper temperature of the filament is attained. The hot filament emits quantities of electrons, or negative charges of electricity (see Chapter XI), and if F is at a higher potential than P these electrons cling to the filament, but when P is at a higher potential than F they are driven from F to P , being negative charges, and a considerable electric current flows from P to F . It should be remembered that a positive electric current is in the direction of motion of positive electric charge, and in the opposite direction to the motion of negative charge. Thus the valve acts as a rectifier, so that the electric oscillations in the aerial and primary coil P_1 , produce similar oscillations in the secondary coil S , which are rectified by the valve FP , and so produce sounds in the telephone T . Thus the valve has a similar rectifying effect to the crystal detector.

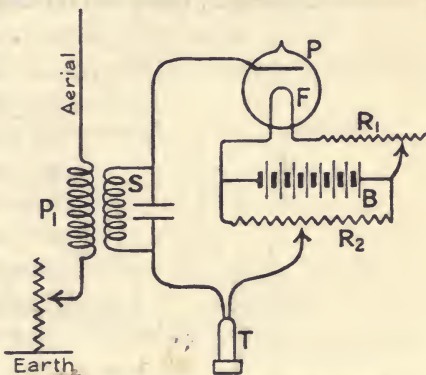

FIG. 109.—Receiving by means of the Fleming rectifying valve.

One of the greatest strides made in radio-telegraphy is due to the addition by L. de Forest, in 1907, of a third electrode or grid to the Fleming valve, thus converting it into an instrument of far-reaching utility, which has received many names. The name *triode* (three-electrodes) appears to be the one likely to become permanently attached to it, although various forms of the instrument have been called respectively *audion*, and *amplifying valve*. The triode has many forms, but they all contain the three parts, a hot filament F , metallic gauze or grid G , and metallic plate P , shown in Fig. 110. The filament is maintained in a state of incandescence by the current from a battery B , consisting

of a few secondary cells, and thus emits quantities of electrons into the space immediately surrounding it. If an electromotive force acts from the filament *F* to the grid *G*, the electrons liberated are driven back to *F* (remembering that they are negative charges), so that no current can pass out from *F* because the bulb, being exhausted to the highest possible vacuum, the only carriers of current are the electrons emitted by the hot filament. Thus, whether or not there is an electromotive force acting from the plate *P* to the filament *F*, there are no carriers of electricity near

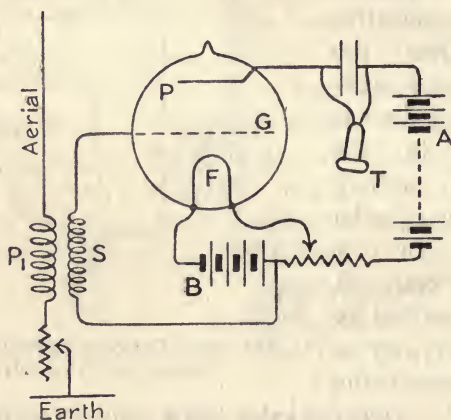

FIG. 110.—Receiving by means of the triode.

P, and the battery *A* of many cells cannot produce any current. On the other hand, if an electromotive force acts from the filament *F* to the grid *G*, electrons stream away from *F*, and many of them pass through the grid and arrive at *P*. The battery *A* is now able to produce considerable current in the direction of *P* to *F*, in fact, owing to its greater electromotive force, it produces a much greater current than that flowing from *G* to *F*. Thus a small variation in electromotive force, acting between the grid and the filament, produces much larger variations in the current from the plate to the filament, than in the current

from the grid to the filament. In Fig. 111 this is illustrated, although the diagram is not drawn to scale. A small oscillating electromotive force acting from grid to filament, whose mean value is Oe , and extremes Of and Og , will produce currents from plate to filament, represented by fb and fc , which are much greater than the current from the grid to the filament. This magnifying or amplifying effect of the triode renders it of the greatest importance in all cases in which small variations in electromotive force or current are to be detected, for it gives a means of magnification of these small oscillations, which could not be detected by the telephone, into larger ones which produce a readily audible effect.

In Fig. 110 the coil P_1 in the aerial circuit acts as primary to the secondary coil S , which is in the grid circuit, and the minute oscillations, being magnified by the triode, produce audible effects in the telephones T . The triode also acts as a rectifier, for if Oe

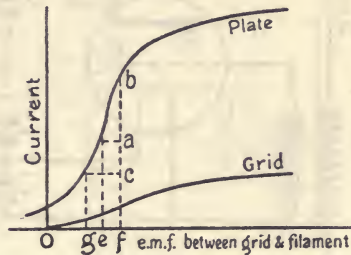

FIG. 111.—Diagram showing the amplifying effect of the triode.

(Fig. 111) represents the average electromotive force acting from the grid to the filament, due to its connection with the positive end of the battery B , and eg and ef represent the extreme variations in the electromotive force due to the oscillation produced by the incoming electromagnetic waves, the current in the plate circuit varies between fb and fc , and the increase ab for one half-cycle is greater than the decrease ac for the other half. Thus rectification occurs exactly as in the case of the simple rectifying valve or the crystal detector. This is due to the upward bend of the plate current curve, and the greatest rectifying effect is produced by working at that electromotive force between grid and filament at which the plate current curve bends up most sharply. A common amount of amplification is

about 7, which means that the signals are multiplied in strength about 7 times; or, putting it another way, the signals will be of the original strength when employing only one-seventh of the original power. Hence much greater distances are now possible for the employment of wireless telegraphy, while for moderate distances much smaller aerials can be used, both for sending and receiving, than could be employed before the advent of the triode.

Still greater magnifications can be attained by using triodes in *cascade*, that is, by using the large variations in

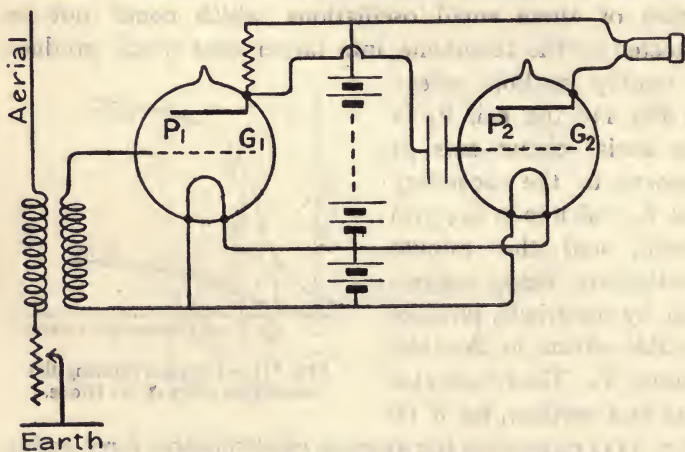

FIG. 112.—Multiplying effect of two triodes in cascade.

current in the plate circuit to produce still greater variations of current in the plate circuit of another triode, whose variations in the plate current are thus a second magnification of the original signals. One method of connecting two triodes in cascade is shown in Fig. 112, in which the small battery heats both filaments, and the large battery is connected to both plates, while the plate P_1 is connected to the second grid G_2 , the telephones being in the circuit of the second plate P_2 . For trans-Atlantic telephone transmission, as many as seven triodes are used in cascade, giving an amplification approaching a million times the original signals.

Another extremely important use to which the triode may be put is the generation of oscillatory currents of the undamped form. For it is clear that if oscillations set up in any way in the plate circuit can, by the employment of part of their energy, be made to produce suitable oscillations in the grid circuit, these latter, by their reaction on the plate current, increase its variation, or at any rate make good the loss which occurs by radiation. Thus in Fig. 113, the grid and plate circuits may be coupled together by the transformer L_1L , so that oscillations in current in L will induce oscillating electromotive forces in L_1 , which if properly connected to the grid G , will have the effect of reinforcing the original oscillations. The effect is somewhat similar to that of a reed in the blowing of an organ pipe, which in being opened and shut by the vibrating column of air in the pipe, allows air to be blown into the pipe at just the correct instants to increase the vibration.

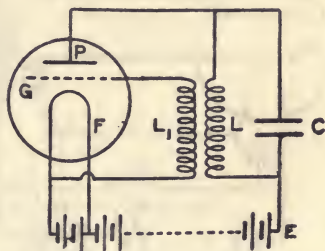

FIG. 113.—Triode used as a generator of oscillations.

One of the greatest marvels of the present day is the transmission of speech or music by wireless means. The condition necessary for success is the production of a microphone which will modify the intensity of the waves emitted by the aerial in a manner similar to that in which the carbon microphone modifies the current from a battery in ordinary telephony (p. 113). Many liquid microphones were tried, whereby the current from the generator (alternator, or electric arc) passed through the liquid, whose resistance was varied by means of the movements of the diaphragm, upon which sound waves fell. The results were only partially successful, and this method has now been replaced by the employment of the triode. For if the current in the plate circuit of the triode, used as a generator, can be

modified by a carbon microphone, so that the fluctuation in intensity follows the motion of the diaphragm of the microphone, the telephones at the receiving station are affected in a similar manner. Instead of the abrupt starting and stopping of the waves produced by a Morse key, which are heard as clicks in the receiving telephone, fluctuations in intensity are produced, following each other at the same

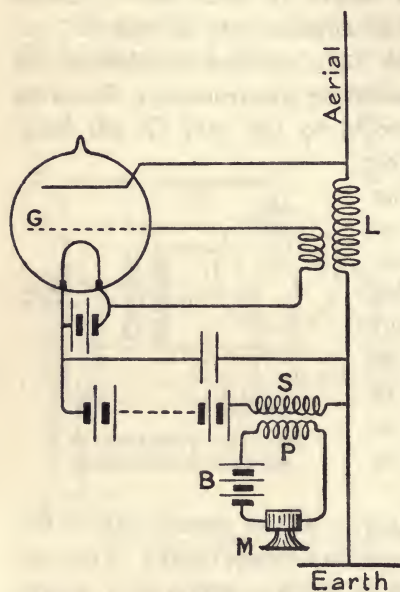

FIG. 114.—Employment of the triode in wireless telephony.

rate as the modification in current produced by the motion of the diaphragm of the microphone at the sending station. There are many methods of bringing this about, and some of them are of great complexity; but a simple method is illustrated in Fig. 114. The microphone M produces fluctuations in the current in the circuit PBM, and the secondary coil S of the transformer PS imposes these variations in current upon the current oscillations in the circuit GLS, which

is arranged to be in the critical state; that is, the oscillations are near the point of ceasing. Current in one direction in S will then cause a large increase in intensity of the oscillations, while the opposite current in S would correspondingly decrease their intensity. In this sensitive condition the variations in current cause very large variations in the intensity of the electromagnetic waves radiated from the aerial. This effect may be illustrated by the curves in Fig. 115. The curve (a) is intended to represent the

current in the coil B, due to the air vibrations of speech acting on the microphone M. The curve (b) indicates the electric oscillations in the aerial circuit, whose fluctuations in magnitude are a copy of the fluctuations in current in P and M (Fig. 114). When the waves emitted reach the receiving station, and the current in the receiving aerial is properly rectified, the diaphragm of the telephone receiver will execute movements which are a copy of the movements of the sending diaphragm, due to the speaker.

Wireless telephony is now an everyday fact, and it has one very great advantage over the older system of telephony

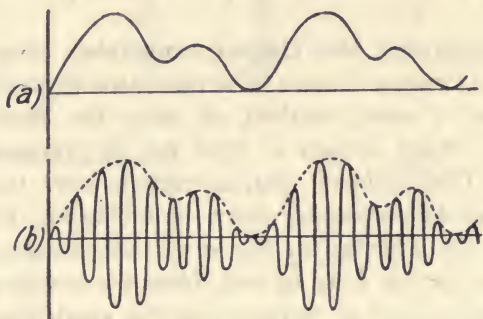

FIG. 115.—Modification of the electromagnetic waves for wireless telephony.

by current carried along wires or cables. For, as we saw in Chapter VIII, the human voice does not consist of simple vibrations but of many vibrations of different frequencies, varying from two or three hundred vibrations per second up to a thousand or more vibrations per second, and it is the mixture of these different frequencies which gives the character to the voice, and determines the nature of the sounds of ordinary speech. It will be remembered also that in Chapter VIII it was seen that waves of current in a cable were attenuated to an amount depending on their frequency or wave-length. Thus, a wave corresponding to a particular sound in ordinary speech is a compound of many constituent waves of different frequencies, and if these

components are attenuated to different amounts, the resulting wave received may bear very little resemblance to the wave transmitted. Hence speech transmitted over a cable 500 miles long may be quite unrecognizable. No such difficulty occurs in the case of wireless telephony, for the electromagnetic waves all travel with the same velocity, whatever their frequency may be, and are diminished from various causes all to the same extent, so that at the greatest distances at which radio-telephony has been attained, speech is as easily recognized as over short distances. Of course, many causes may disturb or limit the transmission, but distortion as known in ordinary telephony is not one of them.

Before closing this chapter, something must be said about the forms and sizes of aerials used in various cases, and about a novel method of using the short electromagnetic waves known as light for the transmission of sounds. The ordinary simple mast or wire used in the early days of radio-telegraphy is inefficient, for several reasons. On referring to Fig. 90, it will be seen that the oscillatory current flows up and down the antenna; but, of course, the current is greatest near the spark gap and gets less and less towards the top of the antenna. If the whole current could be made to flow to the top and down again in each oscillation, the radiation from the antenna would be much more intense. In order to produce this effect, imagine a large condenser to be placed at the top of the antenna, so that the condenser in discharging in an oscillatory manner (p. 151) sends current up and down the antenna. The current at all parts of the antenna will then be the same, and the radiation from it will be much more effective than from a simple antenna. For this reason it is usual to attach the antenna to a horizontal system of conductors or wires. There are several ways of doing this, four of which are illustrated in Fig. 116. (*a*) is known as the inverted L form of aerial, and (*b*) the T form. In the type (*c*) there are two horizontal stretches of wire meeting at an angle,

and this form has a decided directive effect ; the radiation is more intense in the direction to which the angle points than in any other. (*d*) is known as the umbrella type. It is of the greatest importance that the lower end of the vertical or actual radiating wire should be very carefully connected to earth. It is usual to sink a number of metallic plates in the ground where the earth is moist, and thorough metallic connection is made with them.

Much work has been done of recent years to eliminate

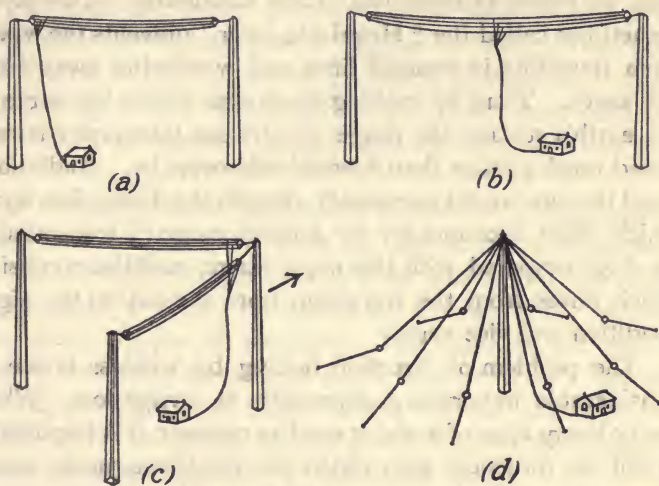

FIG. 116.—Various forms of aerial for wireless.

atmospheric disturbances. Electromagnetic waves of unknown origin frequently disturb the receiving of wireless, and although they may be distinguished by their irregularity from the proper signals, they may at times be so intense that they mask the required signals. Owing to freedom from irregularities, transmission over sea is much easier than over land. Also the useful range for signalling at night is about twice the day range, and the atmospheric disturbances are greatest at dawn and sunset. There is little doubt that the upper layers of the atmosphere are fairly good conductors of electricity. It is well known that

as the pressure of a gas is reduced, an electrical discharge takes place through it much more readily than at the ordinary atmospheric pressure (p. 190). Electromagnetic waves will not travel through gas having appreciable electrical conductivity, but will be reflected by such a layer, just as they are by a metallic conductor. As the electromagnetic waves spread out from a station, they would consequently be confined to a layer of space situated between the earth or sea, and the conducting layer whose altitude may be taken as from 100 to 200 kilometres. This layer, sometimes called the "Heaviside layer," prevents the waves from travelling in straight lines and wandering away from the earth. Thus, by making the waves follow the curve of the earth's surface, the range of wireless telegraphy is rendered much greater than it would otherwise be. Radiations from the sun would necessarily disturb the Heaviside layer, which effect accounts for the limited range of transmission by day compared with the night range, and the confusion which arises from the transition from the day to the night condition and vice versa.

The problem of direction finding by wireless is one of considerable importance, especially in navigation. When the ordinary type of aerial is used as receiver, it is impossible to tell the direction from which the electromagnetic waves come, although their origin may be known from the frequency of the waves, and also by the use of code calls for the particular sending stations. The aeriols shown in Fig. 116 (*a*) and (*c*) both emit a more intense radiation in the direction of the end of the horizontal portion to which the vertical wire is attached than in any other direction, and to this limited extent the radiation is uni-directional. The problem of finding the direction from which waves come has been partially solved by using a loop or coil of wire wound on a rectangular frame as receiving aerial. If the plane of the frame faces the oncoming waves, no effect is produced; but when the frame presents one edge to the waves, a maximum of reception is attained. By rotating the frame until there

is silence in the telephones, the line of the incident waves is known. To discriminate between the two opposite directions which are possible, a single wire aerial has been put in series with the frame, which produces oscillations of such phase that they lessen the effect when the frame points one way towards the source and diminishes it for the other, thus enabling the true direction to be identified. The importance of being able to recognize the direction from which the waves come is now well recognized, and by means of the direction finder described, it is possible to determine this direction within a degree or two. This has already been the means of giving its position to a fog-bound ship, whose direction from two fixed land stations is found from direction finders and then signalled to the ship.

In designing an installation for wireless telegraphy many things must be taken into account, such as range, frequency (or wave-length), height and form of aerial, and power of station supply. These quantities are now becoming known with some degree of accuracy. For example, for transmission over sea a distance of 400 kilometres with T aerials 30 metres high, a wave-length of 600 metres (frequency = 50,000) would be suitable and the power required for constant service about 500 watts, or $\frac{2}{3}$ of a horse-power.

In addition to telephone reception, it is possible to receive by means of the siphon recorder (p. 96) or by some form of relay, so that the message may be printed on the Morse inking machine. When it is not necessary to depend upon the reading of Morse signals by the telegraphic operator, which limits the speed to 20 or 30 words a minute, the use of more rapid methods of sending become possible. The Wheatstone perforating machine has now come into use at several wireless stations, where great numbers of messages have to be dealt with, so that the sending can be carried out at the rate of 100 to 200 words a minute. As this method has been described in Chapter VII, its application to wireless need not be described in further detail.

The advent of the triode has rendered telephonic communication with aircraft a comparatively simple matter, a trailing wire as aerial being quite effective. In this way it is quite easy for a pilot to be in continual touch with his base, and the many advantages resulting from this are sufficiently dealt with in the public press.

There have been many attempts to utilize a beam of light for transmitting sounds, and the method is therefore rather optical than electrical. But the method of reproducing the sound from the fluctuation in intensity of the beam of light depends upon the peculiar electrical properties of the element selenium. This substance changes in electrical conductivity when light falls upon it, the increase in conductivity depending upon the intensity of the illumination. The selenium, in a very thin layer, is mounted so that it can be placed in circuit with a telephone receiver and a battery of a few cells. The selenium layer with its holder and terminals is generally called a selenium cell, but the name is not a good one, because the word "cell," used in connection with the subject of electricity, is generally used to designate the source of electromotive force, as described in Chapter IX.

The employment of a beam of light for transmission of speech is, of course, a wireless method, but it must not be confused with the method of wireless telephony in which the amplitude of the electromagnetic waves emitted by an aerial is modified by a microphone, as described on p. 180. Only recently Prof. A. O. Rankine has devised an arrangement for modifying the intensity of a beam of light so that transmission of speech may be effected over a mile or so. Light from a bright source A falls upon a lens L_1 and is brought to a focus on a little concave mirror M. This mirror reflects the light to the lens L_2 which brings it to a focus at the distant station, which effect may be assisted by other lenses if necessary; the optical arrangements are not described here in detail. At the receiving station is the selenium cell S, with battery B and telephone receiver T in

circuit. The novelty of Rankine's method lies in the manner in which the intensity of the beam of light is caused to vary by the air waves of speech. G_1 is a set of opaque lines or grid, seen end-on in the figure, with transparent spaces between the lines. At G_2 is an exactly similar grid, and the distances of the two grids from the mirror M are arranged so that M throws an image of the grid G_1 upon the grid G_2 . Now it follows that if the light passing through the clear spaces of G_1 falls upon the opaque lines of G_2 it is all stopped and none gets to S . But if the light from the clear spaces of G_1 falls upon the clear spaces of G_2

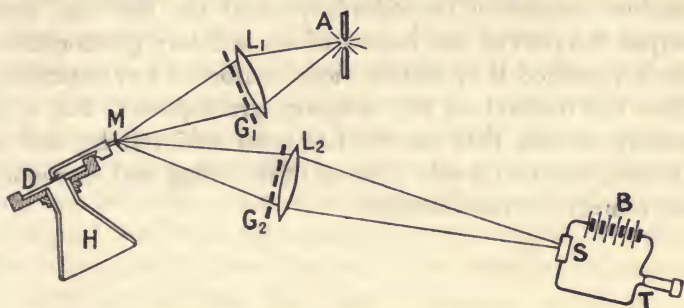

FIG. 117.—Rankine's method of transmitting sounds by means of a beam of light.

it gets through and proceeds on its way to S . Thus a very small shift of the image of G_1 , as it falls upon G_2 , influences the amount of light which proceeds to S to a very large extent. M is attached to a lever, the other end of which rests on a diaphragm D , like that of a gramophone, and sound waves entering the horn H are therefore able to make the mirror M vibrate in time with themselves, and so to impress corresponding fluctuations on the intensity of the beam of light proceeding to the selenium cell. With this arrangement speech has been transmitted for distances exceeding a mile, with excellent clearness. With intense source of illumination, such as the sun, and improvements in design, there is little doubt that the range will be considerably extended.

A further interesting feature may be noted ; for if the image of the source, interrupted by the voice waves, as explained above, be allowed to fall on a sensitized cinematograph film, the intensities of the images produced after development in the ordinary way, will form a permanent record of the variations in intensity of the beam of light. If, then, the film be passed before the selenium cell, so that a strong beam of light falling on the cell is made to traverse the images, the light falling on the selenium will vary in intensity in the same manner as the original beam. The response of the selenium will therefore reproduce the original sounds in the telephone, and the film has thus played the part of the record of an ordinary gramophone. Such a method is of course more cumbrous and expensive than the method of the ordinary gramophone, but it is worthy of note that success has been achieved by such a method, and that a new method of recording and reproducing sounds has been devised.

CHAPTER XI

GASES AND X-RAYS

THE work of Maxwell brought to a close one particular era of development in our knowledge of electricity and at the same time opened the next era. The ingenuity and perseverance of Faraday laid the foundation of understanding the interaction of an electric current and a magnetic field. But Faraday, although he gave a vivid picture of the processes that he considered to be going on whenever action occurred between a magnetic field and a conductor, never attempted to give his ideas quantitative precision. Perhaps the most important development in the mathematical theory of electricity between the time of Faraday and that of Maxwell is due to Kelvin, in his calculation of the manner in which the charge from a condenser will leak away through the conductor which joins its plates. This had an important effect in the realization of electromagnetic waves, which ultimately led to wireless telegraphy and telephony. The era following Maxwell is characterized by two parallel lines of development, and, while that leading to electromagnetic radiation has been followed in Chapter X, we must now turn our attention to the other. This latter, although it may not be so useful commercially as the former, has led to a profound modification of our knowledge of the constitution of matter, and in this prolific field of investigation it must follow that developments of the highest practical service will result.

Many investigators had been struck by the beautiful phenomenon of the passage of an electric current through a

rarefied gas. Faraday himself had noticed that on passing a current or electric discharge, as it is frequently called, through a glass tube in which the air had been rarefied, certain distinctive effects always occurred. On pumping the air out, to lower the pressure, and passing a current between two platinum terminals K and A (Fig. 118) by means of an induction coil which produces a high electromotive force, the successive changes in the character of the discharge may be observed. When very little air has been removed, the track of the current is luminous, and consists of a sinuous path, like a lightning discharge, and at the same time a crackling noise is heard. On removing more air, the discharge passes more easily, it becomes straighter,

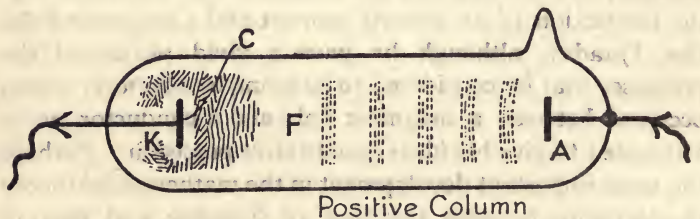

FIG. 118.—Electric discharge at moderately low gas pressure.

and the crackling ceases. When the pressure in the tube has been reduced to about a quarter of the ordinary atmospheric pressure, the stream has broadened considerably and is coloured pinkish or lavender. On reaching a pressure of about one-hundredth of an atmosphere, these changes have proceeded further, but in addition, a distinct difference between the two ends of the discharge is observable. The luminous column extends quite up to the anode A (Fig. 118) at which the current enters the tube, but before reaching the cathode K, by which the current leaves, there is a distinct break in the column, constituting a dark space F. Faraday noticed this dark space near the cathode, and it has been named after him the **Faraday dark space**. Between the Faraday dark space and the cathode is a slight bluish glow called the **kathode glow**. This was as far as Faraday

could proceed, because the means for rarefying the air still further were wanting in those days.

The Geissler tubes, which exhibit this effect so beautifully, are merely tubes in which a current passes through gas at a moderately low pressure; but different kinds of gas give variously coloured discharges which fill the tube. Among others, Hertz endeavoured to find the explanation of the wonderful effects of the discharge through gases at low pressures. It was thought by all who contemplated this discharge that the proper understanding of it would reveal the explanation of many other phenomena, but no one could imagine the profound extension of knowledge which would eventually follow from the unfolding of the mystery contained in the discharge tube.

A great advance was made by Sir William Crookes on carrying the exhaustion of the tube to stages beyond that attained by previous experimenters. At a pressure of about a thousandth of an atmosphere, the Faraday dark space F (Fig. 118) separating the kathode glow from the rest of the discharge, called the positive column, has increased, and the positive column itself has become resolved into luminous discs separated by dark spaces, which luminous discs are known as striations. But more important than these is a second dark space, appearing between the kathode glow and the kathode, discovered by Sir William Crookes, and named after him, the **Crookes dark space C** (Fig. 118). Further exhaustion of the tube causes the scale of the whole phenomenon to grow. But it *grows from the kathode*, the other parts disappearing as there is no longer room for them in the tube. First, the positive column goes, then the Faraday dark space, then when the kathode glow goes too, the Crookes dark space fills the whole tube. It is with considerable difficulty that the current can be made to pass through a tube exhausted to such a great extent that the ordinary phenomena of the discharge are absent, the Crookes dark space alone remaining. It might at first sight be thought that this dark space is a mere void, in

which nothing is occurring ; but Crookes found that this is not the case. Many minerals, if situated in it, glow brilliantly, each with a characteristic colour. In fact, the walls of the glass tube glow with a brilliant greenish yellow if the tube is made of soda glass, and a pale blue if the tube is of lead glass. Further, an obstruction between the kathode and the walls of the tube casts a shadow on the walls, showing that something is travelling outwards from the kathode, which on striking the walls of the tube causes the luminescence. Crookes also showed that a light and delicately suspended body is driven away from the kathode as though it experienced a pressure. Obviously something in the form of rays is travelling outwards from the kathode producing the effects observed. The general name of **kathode rays** was given to them, but whether they consist of particles of matter shot out from the kathode, or of waves such as light, was at that time an open question. Crookes hazarded the guess that in the dark space was matter in a *fourth condition*, that is, it was neither solid, liquid, nor gas. The guess was prophetic, as it was afterwards found that the kathode rays consisted of matter in a form hitherto unsuspected.

Rays consisting of waves, such as light, are entirely undeflected by a magnetic field, but a very simple experiment serves to show that a comparatively feeble magnetic field will cause a bending of the kathode rays. On cutting the kathode rays down to a narrow beam by means of a metallic screen A (Fig. 119) in which a slit has been cut, and allowing the beam to travel nearly parallel to a metal sheet AB upon which a layer of zinc sulphide has been spread, the track of the beam is marked by a vivid blue band, because the rays cause a blue luminescence in this substance. Under ordinary circumstances the band is perfectly straight, showing that the kathode rays travel in straight lines. But if the pole of a magnet N is brought near the tube, the band becomes curved, showing that the rays experience a force, at right angles to the rays and also

at right angles to the magnetic field. It will be remembered that this is exactly the kind of force which an electric current experiences in a magnetic field (p. 40). The ordinary laws which apply to an electric current under this condition lead to the conclusion, that if the kathode rays do really constitute a current, it must be a current of *negative electricity*, because the rays are obviously travelling away from the kathode, and the direction of the deflection by the magnet is opposite to that which a positive current would experience. It is therefore concluded that the kathode rays consist of bodies having charges of negative electricity, travelling away from the kathode. This con-

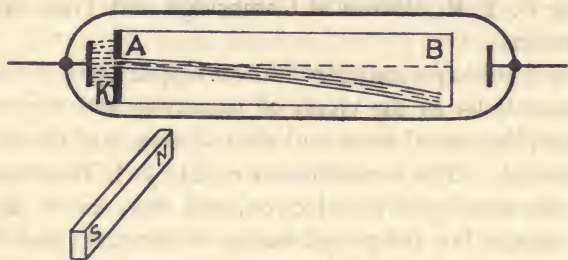

FIG. 119.—Bending of the kathode rays in a magnetic field.

clusion is quite in accord with the other properties of the rays, and is corroborated by the fact that if the rays are caught by a hollow conductor placed to receive them, the conductor is soon found to have acquired a charge of negative electricity.

The proper understanding of the nature of the bodies which constitute the kathode rays we owe chiefly to the work of Sir Joseph J. Thomson, who found their velocity by measuring the displacement produced by a magnetic field and also that produced by an electrostatic field. In the latter case, the negative charges of these bodies are repelled by a negatively charged conductor and attracted by one positively charged. Without mathematical discussion it is impossible to follow the reasoning by which the quantities

concerned were measured, but it was eventually found that the velocities of the kathode ray particles were of the order of 30,000,000 metres per second, although this velocity varies under different conditions. But the most important result of these investigations lies in the fact that these particles are of the same nature, whatever the kind of gas which fills the tube, or whatever the material of which the electrodes are made. Also their mass is only about one two-thousandth part ($\frac{1}{1850}$) of the mass of the smallest quantity of matter which had hitherto been known ; that is, the mass of the atom of hydrogen. The name of **electron** has been given to these bodies. Many workers have contributed to our present knowledge of their mass, notably C. T. R. Wilson at Cambridge and Prof. Millikan in America.

The cloud experiments of Wilson supplied one of the most important links in the chain of reasoning and experiment by which the actual mass and electric charge of the electron were found. The experiments of Sir J. J. Thomson had given the velocity of the electron, and the ratio of its mass to its charge, but the actual values of the mass and charge were still uncertain. It is true that from the value of this ratio, it was suspected that its mass was of the order of one-thousandth of the mass of an atom of hydrogen, but as no quantity of any material as small as this had ever been detected as having an independent existence, it became of the greatest interest to establish its value by experimental means. The reasoning employed is somewhat as follows: the current through an ionized gas (p. 202) could be measured, and if the velocity of the ions could be measured, and the number present could be found, it follows that the charge upon each ion could be calculated. The velocity was found by many observers without any great difficulty, but the number of ions present in the gas and available for carrying the current was first determined by the cloud experiment. It had long been known that air saturated with water vapour and suddenly cooled, gave rise

to a cloud or fog, the moisture condensing to form small drops. These drops, however, require some small body, such as a dust particle, to form upon. In dust-free air, cloud or fog is not formed. Again, every small drop falls through the air at a rate depending upon its size, so that if a cloud is produced in an enclosed vessel and then allowed to settle, the drops drag the dust particles down, and will, after a few repetitions of the cloud formation, free the enclosed space, so that no cloud will be produced. C. T. R. Wilson's discovery consists in the fact that if the dust-free air be ionized by means of passing X-rays (p. 200) through it, a cloud may be produced again quite easily, and he showed that the ions produced by the X-rays acted in a similar manner to dust particles in the formation of the cloud. From the work done in cooling the air, the total amount of water condensed could be calculated, and from the rate of settling of the cloud, the size and mass of the drops is known, so that the number of drops formed is obtained by dividing the mass of water formed by the mass of each drop. Now each drop had an ion as nucleus, so that the number of ions present is found. This completes the chain of argument, and enabled the charge on the electron to be evaluated. In Fig. 120 (*a*) (Plate IV) photographs are shown of the passage of a beam of X-rays through air saturated with water vapour, taken by an apparatus of improved form by C. T. R. Wilson. The drops formed by condensation on the separate ions can be detected. This is probably the first method by which individual bodies as small as the ion have been individually observed. The method was afterwards improved by Millikan, who, by means of an electric field, separated one drop from the others and afterwards measured its rate of fall, so obtaining a more exact value for the electronic charge than had been previously found. In Fig. 120 (*a*) (Plate IV) the spider's web-like lines each represent the track of an electron, or β particle (p. 209), and are seen to consist of a succession of dots, each dot representing a cloud formed by

condensation on the ions produced when the electron strikes an atom of the atmosphere. Fig. 120 (*b*) (Plate IV) is an exceedingly beautiful photograph of the same process and is more magnified than (*a*).

The charge of electricity associated with the electron is the same, whatever the source of the electron, and it is exactly the same as that carried by an atom of hydrogen or any other mono-valent element met with in electrolysis (see Chapter IX). The electron appears therefore to be, not only found universally, but to be the ultimate or smallest part of electricity which exists. Every atom contains electrons, some of which are fixed to it and one or more of which may be detached from it. With its complete number of electrons an atom is electrically neutral; when it loses an electron, which is of course a negative charge, it becomes on account of this loss positively charged. Whether the remainder of the atom, which is enormously greater than an electron, consists of a collection of electrons in some stable form, or whether it is matter in some other form, is not yet definitely known, but many investigators are at work on this problem. But it is already known, with a high degree of certainty, that most of the electrical properties of matter are due to electrons and their movements. It is difficult to estimate the enormous strides made in the understanding and explanation of electrical phenomena by the discovery of the electron. One of the greatest mysteries was, for a long time, the conduction of electricity through metals and the phenomena allied to it. Although perhaps the earliest discovery, that electricity could traverse metals, the secret of the solid state was profound. The veil is only partially lifted at the present time, but what we can see, gives promise of the further clearing away of the difficulty of explanation of the process of conduction in metals. It is known that free electrons exist in numbers in the spaces between the atoms, and on applying an electric field to the conductor, the electrons are driven along, so constituting the electric current.

In insulating materials there are no electrons outside the atoms of the substance, and any electrons within the atoms can only be moved very small distances by an electric field, since they are still confined within the atoms. In this way the conductivity of some materials and the insulating power of others is explained. Many other electrical properties find a similar explanation, but their consideration will be found elsewhere.

In the discharge tube it becomes clear that the current flowing through the gas consists, at least in part, of a stream of electrons passing from kathode to anode. When an atom loses an electron it must become positively charged, because it was neutral before losing the electron. It would be expected, on these grounds, that positively charged atoms should be present in the gas. Their detection, however, is a matter of difficulty, because they would be urged in the direction of the kathode by the electric field maintaining the current in the gas, and would reach their greatest velocity near the kathode, where the field is most intense. The mass of even the smallest of such bodies, the hydrogen atom, is nearly 2000 times as great as the electron, and its velocity in the electric field would consequently be very much less than the electronic velocity. Moreover, it strikes the kathode at the end of its travel, and would therefore escape detection.

It occurred to Goldstein, in 1886, to perforate the plate constituting the kathode, so that the positively charged particles could pass through it by reason of the momentum acquired in the electric field. He observed faint streamers of light behind the kathode, which obviously consisted of streams of these particles. They are called *canal rays* from the mode of their production.

Immediately after the discovery of the existence of the canal rays it became of interest to apply to them the same methods that were so successfully applied by Sir J. J. Thomson to the kathode rays. The deflection of the canal rays by an electric field is an easy matter, and shows, from

the fact that they are deflected in the opposite direction to that for the kathode rays, that they are positively charged bodies. Owing to their greater mass and smaller velocity they are not so easily deflected by a magnetic field as are the kathode rays. Much stronger magnetic fields are required to produce measurable deflection, but when these are applied, the measurements show that the bodies constituting the canal rays are the atoms of the gas used in the discharge tube. Also, some of the atoms have lost one electron and therefore have a single positive charge, some have lost two electrons and therefore have a double positive charge. In fact, with mercury vapour, some of the atoms of mercury are found to have as many as eight of these units of positive charge. By a modification of his original method, and using a very high vacuum in the discharge tube, Sir J. J. Thomson was enabled to identify, not only the atoms of various gases, but groupings of atoms, called molecules.

A further improvement of the method by F. W. Aston has enabled spectra of the canal rays, or positive rays, to be produced, in which the lines corresponding to various kinds of atom are arranged so that the equal spacings between them correspond to equal increases in mass of the atoms. The most significant fact about those lines is, that they are separated in most cases by distances which indicate distinct jumps of two in the atomic weights. Also in some cases a given element will be represented by several adjacent lines showing that it may exist with several different kinds of atom, and the ordinary substance, which to the chemist was previously considered to consist of simple atoms all alike, is in reality a mixture of atoms, differing in atomic weight by two from each other. Such varieties of atoms in the case of a substance have been named **isotopes**. This removes the anomaly of the elements which depart from the whole numbers, since the mixture of isotopes would have an atomic weight intermediate in value between the extreme values for the separate atoms. The theory that all matter consists of atoms built up in various ways from hydrogen

atoms has, therefore, been resuscitated by the phenomena of discharge through gases.

Returning to the cathode rays, these have one very important property which has not yet been mentioned, which must now be considered. In the year 1895, Professor Röntgen found that certain photographic plates which had not been exposed to light were, nevertheless, "exposed"; that is, on developing the plates in the ordinary way, they were found to have been acted upon as though by light. The only possibility seemed to be that, as they had been situated near a discharge tube at work, they were affected by some unknown rays which had the same effect upon them as light, but, unlike light, these rays could penetrate the cases in which the plates were contained. A more careful investigation showed Röntgen that such rays were emitted from the discharge tube, and since these rays were of an unknown kind he called them **X-rays**, to emphasize their unknown character. They have since been called both Röntgen rays and X-rays, but the latter name has been, by custom, more particularly attached to them. It was found that whenever cathode rays fall upon a dense material, the point of impact is a source of X-rays, and that these rays can pass easily through the glass walls of the discharge tube, and through most ordinary substances. The penetrability of substances by X-rays depends almost entirely upon the density of the substances, those of small density are highly penetrable, while a small layer of a dense material, such as lead, will prevent the passage of any appreciable quantity of the rays. The presence of X-rays may be detected in two ways: by their action upon the photographic plate, and by the fact that when they pass through any gas, they cause it to become a conductor of electricity. All pure gases are practically non-conductors of electricity, but when a gas has been rendered conducting by the passage of X-rays through it, it is said to be **ionized**. The former of these two methods, the photographic, has led to most important applications of X-rays for photographic purposes, while the latter or

ionizing effect has played the more important part in investigating the nature of the rays, and led eventually to the new and vast region of scientific knowledge known as radioactivity.

The phenomena of ionization of gases have led to such great steps in our knowledge of the understanding of the nature of matter, that it is necessary to describe them somewhat in detail. All pure gases such as oxygen, nitrogen or air, are non-conductors of electricity, and the simplest method of exhibiting this property is to make use of the gold leaf electroscope. This consists of a pair of leaves of thin metallic foil C (Fig. 121) suspended from a wire B.

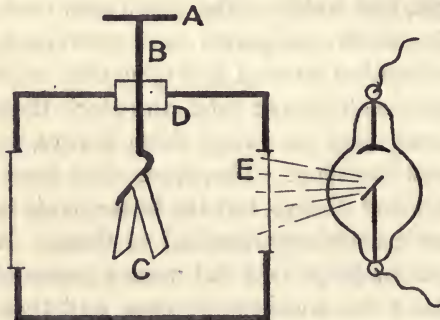

FIG. 121.—Measurement of the ionization produced by X-rays.

The leaves may be of gold, aluminium, or any other metal that is procurable in the form of thin light leaf. The wire and leaves must be well insulated by passing the wire B through a supporting block of sulphur or of paraffin wax D, which will not conduct electricity when its surface is kept clean. At the upper end of B is usually a metallic knob or plate A, and the whole is carried by a metallic box having windows, one of which is seen at E. On rubbing a piece of amber, or better, a rod of ebonite, with dry fur, the rod becomes electrified and on bringing it into contact with A, some of the electricity is communicated to A. Owing to the conductivity of A, B, and the gold leaves C, the charge of electricity becomes distributed over them, and the leaves will

stand apart, as shown in the figure, because the charges on the two leaves, being of the same kind, repel each other. The leaves will remain charged for a considerable time, if no conducting material is brought into contact with the electroscope. But if A is touched by a wire, the charge of electricity escapes at once, and the leaves collapse instantly. Even substances which we should call bad conductors for ordinary electric currents, are found by this delicate test to be moderately good conductors. Thus, on touching A with the finger the leaves collapse instantly, the charge passing away through the hand and body; but if dry wood or cotton held in the hand be put in contact with A, the leaves collapse slowly, showing the poor conducting power of these substances. The fact that the leaves will remain charged for a long period, shows that the air in contact with the electroscope is an almost perfect non-conductor, for if the block D is in good insulating condition, the charge will remain for hours, with very slight loss.

On placing an X-ray tube opposite one of the windows of the electroscope so that the X-rays enter the chamber, the leaves instantly collapse, showing that the charge of electricity has been conducted away with great rapidity. A similar result may be obtained by leading air from the neighbourhood of an active X-ray tube, through a wide tube into the chamber of the electroscope, which shows that the collapse of the leaves is due to the fact that the passage of X-rays through the air has converted it into a conductor of electricity. The air soon recovers its insulating property, and on repeating the first experiment with the X-ray tube moved further away from the window, it will be found that the leaves still collapse, but more slowly. The effect can still be observed with the X-ray tube many yards from the electroscope, provided that the X-rays pass through the window, but the collapse of the leaves becomes slower and slower, the further the X-ray tube is removed.

We have seen that when the air in the electroscope has been rendered a conductor of electricity it is said to be

ionized. The process of ionization is not easy to understand, but it may be explained roughly, by saying that each atom of the gas is really a complex body containing at least one electron, or fundamental portion of negative electricity which is detached from the atom by means of the X-rays. The remainder of the atom is therefore deficient in negative electricity by the amount of that detached, and is said to be positively charged. Remembering, then, that positive and negative charges of electricity attract each other, the escape of charge of the electroscope can now be understood. For whichever the sign of the charge of electricity on the leaves, that is, whether it be a positive or a negative charge, it will attract the charges of opposite sign in the gas. If the leaves are positively charged, they will attract the electrons which, being negative electricity will on reaching the leaves, neutralize the positive charge upon them. Similarly if the leaves are negatively charged they will attract the positively charged remainders of the atoms, which will neutralize the negative charges on the leaves ; in either case the leaves become discharged. The electrons and the positive remainders of the atoms of the gas are generally called ions, negative ions and positive ions ; hence the word " ionization " as applied to a gas when in this conducting condition produced by X-rays. It is by no means certain how the X-rays release the electrons from the atoms. The latest work tends to show that the atom, even the simplest (an atom of hydrogen), is not a simple structure. It consists of a nucleus or central portion around which, at comparatively great distance, smaller bodies or electrons revolve. It is not certain that the ordinary laws of attraction hold at the minute distances within the atom, but there is certainly some force of attraction between the nucleus and the electron or electrons rotating around it, which force keeps the electron, under normal conditions, from flying off, in a manner similar to that in which the planets are prevented from flying away from the sun by gravitational attraction while revolving

round it. The comparison is useful, although the attraction is of different kinds in the two cases.

Perhaps a nearer parallel might be found in the ring surrounding the planet Saturn, where the ring consists of a cloud of particles revolving round the planet. No comparison with the gravitational case can be perfect, for it appears that in the atom, one or more electrons are easily detachable. Those atoms which the chemist designates as mono-valent, such as hydrogen, sodium, chlorine, etc., can easily lose one electron; a divalent atom, such as oxygen or calcium, can lose two electrons, and so on. It can easily be seen that a powerful electrical field lasting for a short time, such as constitutes an X-ray pulse, will disturb the steady rotation of the electrons around the atom, just as though a violent blow were given to the system, and the possibility then arises that the more loosely held electron can escape.

Under normal conditions, every atom has its full complement of electrons, the proof of which is that a gas as a rule exhibits no electrical properties. It is completely uncharged, which means that there is exactly as much negative as positive electricity in the whole of its atoms; and it is a non-conductor of electricity, which shows that each atom is exactly neutral; that is, the electrons present constitute an amount of negative electricity exactly equal to the positive electricity associated with the nucleus of the atom. The proof of this lies in the fact that a charged body will remain charged in ordinary air although it is being bombarded millions of times per second by the molecules of the gas.

The difficulty of investigation of the constitution of an atom can be realized by considering the actual sizes and masses concerned. As a rough simile, Lord Kelvin stated that if a drop of water could be magnified to the size of the earth, the individual molecules would then be about the size of cricket balls. The opposite perhaps appeals to the imagination more. Think of the earth as made up of

cricket balls, and then suppose it to shrink to the size of a drop of water. The mind cannot follow the corresponding shrinkage of the cricket balls. Putting it more exactly, the number of molecules in a cubic centimetre of gas under ordinary atmospheric conditions is known from the kinetic theory of gases to be about 27,100,000,000,000,000. Each molecule consists of two atoms. The simplest atom or atom of hydrogen, contains electrons, one of which it can lose, and the electron is only $\frac{1}{1850}$ part of the atom of hydrogen. All the other substances have atoms heavier than the hydrogen atom. The substance with the heaviest atom is uranium, the atom of which is equal in weight to 236.6 hydrogen atoms. Thus the electron is only equivalent to $\frac{1}{437000}$ part of an atom of uranium.

In a very highly rarefied gas, the electron situated in an electric field acquires very great velocity, as we have already seen. But in a gas under ordinary conditions the velocity acquired is not nearly so great, for two reasons. First, the electron soon becomes loaded up with neutral molecules of the gas, which add enormously to its mass, without increasing the force upon it; and, secondly, the ions so produced collide with the other molecules of the gas, so that their progress is not unrestricted as it is in a vacuum. In air at ordinary temperature, the velocity of the negative ions is 1.78 centimetre per second in an electric field of 1 volt per centimetre, and for the positive ion 1.4 cm. per sec. For hydrogen the numbers are 7.43 and 5.4, and for carbon dioxide 0.81 and 0.76. This shows that the larger and heavier molecules amongst which the ions have to push their way restrict their velocity, while the lighter molecules, such as those of hydrogen particularly, do not hinder them so much.

The two streams or drifts of ions through a gas, positive in one direction and negative in the other, constitute the electric current in the gas, and the reader has probably noticed that the current in a gas bears a great resemblance to the current in an electrolyte, where the ions are pushed

through the liquid by the electric field applied by the battery. In fact, the velocities of the ions are similar in magnitude in the two cases. It is likely that all electric currents, even those in metals, are of this same kind, being a drift or current of electrons, and possibly of positive ions, produced by the applied electric field.

One of the earlier forms of vacuum tube for the production of X-rays is shown in Fig. 122. A glass bulb has an aluminium cathode K and a platinum anode A, set at an angle of 45° to the line joining the two. The tube is exhausted until the Crookes dark space fills it entirely, and, since the kathode rays travel perpendicularly outwards from the cathode, by making this concave, the kathode rays are concentrated upon a small spot of the surface of the platinum anode A. This small spot may even be rendered red hot by the bombardment of the electrons constituting the

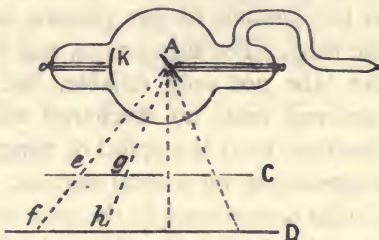

FIG. 122.—Early form of X-ray tube, showing how the rays originate at a point on the anti-kathode.

kathode rays. It is also an intense source of X-rays. This fact may be proved by placing a lead sheet C, with holes *e*, *g*, etc., bored through it, over a photographic plate D. After a short time the plate D is removed and developed, when black spots appear at *f*, *h*, etc., and on replacing the plate and drawing the lines *fe*, *hg*, etc., it may show that the rays producing the spots all come from a small region of A.

The above method explains the use of an X-ray tube for examining the internal region of bodies in surgery. For if the lead sheet C be replaced by a living limb, the X-ray shadow cast upon the photographic plate D exhibits the internal structure of the limb. Bony parts, being more dense than the fleshy parts, cut off the X-rays to a greater

extent, and so produce lighter parts in the resulting negative. Any foreign metallic body, such as a bullet, casts a sharp shadow and is easily located. In modern X-ray pictures, or radiographs, even the smaller variations in density of the tissues are apparent. Fig. 123 (Plate III) gives examples of such a case, (*a*) showing a fracture of the humerus by a bullet, and (*b*) a fracture of the ulna by a piece of shrapnel.

A modern form of X-ray tube of high efficiency, the Coolidge tube, is shown in Fig. 124 (Plate III). In the older types of tube, the source of electrons for the kathode rays is the residual gas in the tube. After pumping has been carried on to low pressure, the unavoidable variation in the amount of gas present causes irregular working of the tube. For this reason, and to render the behaviour of the tube not only reliable, but under control, the gas is removed until no discharge will pass, and the source of electrons used is a spiral of tungsten wire raised to a high temperature by a local current. We have already seen a similar device used in the case of the triode (p. 176), which revolutionized radio-telegraphy, in fact, the emission of electrons by bodies at high temperatures has become a very important branch of study, most particularly developed by Prof. O. W. Richardson, and called *thermionics*. By means of an induction-coil or transformer, the tungsten is made the kathode for the discharge, and the electrons are driven against a massive anti-kathode or target made of tungsten, from which of course the X-rays arise. For the purpose of focussing the kathode rays upon the target, a shield of the metal molybdenum is used, the shield having various shapes, according to the use of the tube.

The great advance which has been made in the efficiency of X-ray tubes may be realized from the fact that with the early tubes, an exposure of five minutes to half an hour was necessary to obtain a good radiograph, whereas with a modern tube the times vary from a third of a second, when radiographing the human fingers, to 48 seconds for the



FIG. 123.—(a) Fracture of shaft of humerus by bullet. Bullet lying between fragments.

[From Kaye's "X-Rays."]



FIG. 123.—(b) Fragmentation of ulna by shrapnel.

[From Kaye's "X-Rays."]

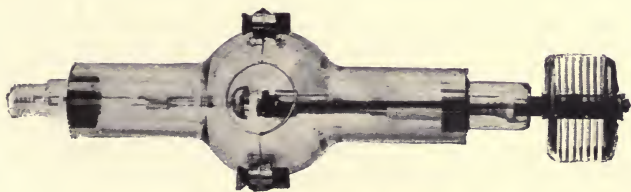

FIG. 124.—Coolidge X-ray tube in lead glass shield.

head, although of course it must be remembered that part of this improvement is due to the advances made in the manufacture of suitable photographic plates, more particularly by adding calcium tungstate to the sensitive film.

It is beyond the scope of this book to enter into any account of the medical uses to which X-rays have been put, but it is worthy of note that not only may metallic objects, fractures, and diseases be located, but, by administering opaque insoluble salts of bismuth to a patient in the food, sufficient quantities may be accumulated to render the gullet, stomach, and intestines sufficiently opaque to X-rays for their study radiographically. From this treatment many inter-related functions of the various organs have been brought to light. X-rays are also employed for the detection of flaws in wood or metal and faulty weldings between metals. Their range of usefulness is increasing daily.

The nature of the X-rays was for a long time imperfectly understood. X-rays are not deflected by a magnet, and do not carry any electric charge. Hence they differ essentially in character from the kathode rays to which they owe their origin. It was thought at first that they could not be reflected or refracted like light waves, but this has since been accomplished. When X-rays fall upon matter, other or secondary X-rays are found to be emitted, and in late years these secondary X-rays have given us much information upon the constitution of matter. The most important case of reflection of X-rays is that in which the reflection takes place internally in crystals. Light when reflected from a mirror on which very fine parallel lines have been ruled, exhibits patterns, due to the rulings and to the wave nature of light. They are called interference patterns, and are similar in character to the patterns seen on the surface of water when regular ripples or waves are reflected from a wall. These interference patterns are only produced in the case of waves. In the case of light, they constitute proof of its wave-structure, and distinguish it from a stream of particles travelling with high velocity,

such as we have seen in the case of the kathode rays. For many years attempts had been made to obtain interference patterns with X-rays, and the failure to observe them suggested that X-rays might not consist of waves. The failure, however, was due to the fact that no set of rulings, that is, no diffraction grating, as it is called, was of fine enough structure to produce interference patterns. It occurred to Prof. M. Laue, in 1913, to try the effect of substituting a crystalline material for the artificially ruled grating employed in the case of light waves. He was rewarded by finding that on passing a beam of X-rays through various crystals, the central beam was surrounded by smaller beams. These produced symmetrically arranged spots surrounding the central spot, when a photographic plate was placed to receive the beams. This shows that the X-rays are reflected differently in different directions by the crystal, the atomic structure of the crystal being fine enough to act towards X-rays as the rulings of a diffraction grating act towards light waves, although in a more complicated manner. The interpretation of the results presented considerable difficulties, but Sir William H. Bragg has succeeded in showing that the structure of the crystal may be discovered by considering the reflection of the X-rays to take place at planes in the crystal which are rich in atoms. In this way one of the great mysteries, that of crystalline structure, has been solved by means of the behaviour of X-rays.

The waves which constitute X-rays are of the same character as light waves, but they are very much shorter. A wave of light is about 0.00006 centimetre long, but the length of a wave in X-rays is about 0.0000001 centimetre. With the exception of the γ -rays (p. 220), which are of the same nature as X-rays, this is the most minute wave of which we have any knowledge, and it is on account of the smallness, or rather the shortness, of these waves that X-rays have such great penetrability for ordinary matter.

CHAPTER XII

RADIOACTIVITY

IT is always difficult to attach the true relative importance to a branch of scientific development. In one branch the application may be wide, or of particular industrial value, so that every one has a knowledge of it; the newspapers chronicle every advance and the names of those who apply the fruits of scientific research to commercial purposes become household words. Such to a conspicuous extent is the case with wireless telegraphy. But intelligence of other branches of work, of perhaps more profound significance, only reaches the public faintly, and the names of the great workers in such branches are almost entirely unknown outside scientific circles. As a good example of this, the subject of the present chapter may be taken. Radioactivity is a process so widely spread and yet, in its most violent occurrences, so remote from everyday life, that probably not one person in a hundred could give the name of the worker to whom our knowledge of radioactive processes is chiefly due.

In 1896 Prof. Henri Becquerel, of Paris, was examining salts of the metal uranium, to find out what kind of radiation is emitted by them after being exposed to sunlight. Such emission is called phosphorescence, but it must not be confused with the phenomenon of luminescence exhibited by certain substances, particularly those in a state of decay, due to the oxidation of the phosphorus contained by them. The latter process is chemical phosphorescence in distinction

to the physical phosphorescence exhibited by diamond, and certain salts such as zinc sulphide, and calcium sulphide, which emit light in the dark for some time after being exposed to bright illumination, a common example of which is Balmain's luminous paint. Becquerel was examining the substance uranium to see if its phosphorescence was accompanied by the emission of X-rays, as in the case of the glass walls of an X-ray tube, by putting it in close proximity with a photographic plate in the dark, and subsequently developing the plate, the uranium having been previously exposed to sunlight. But it was found that when the uranium had not had any preliminary exposure to sunlight the marking of the plate was still clearly developed. It appeared, therefore, that the exposure to sunlight was not necessary for the emission of the rays which produce the photographic effect. A test experiment was made by producing the uranium salt and crystallizing it from the solution in the dark, so that the solid crystals had never been exposed to daylight. The result was just as marked as before; consequently the rays which produce the photographic effect are emitted spontaneously by the uranium salt and are not the result of energy absorbed from light. The name of "Becquerel rays" was given to them, but it was eventually found that they are of such a complex character that the original name gave place to particular names applied to their constituent parts.

The emission of Becquerel rays by uranium was at first difficult to explain. An emission of rays which produce a photographic effect necessarily involves the continual using up of energy, the source of which was not in this case obvious. If the rays were emitted only after exposure to light, it would naturally be thought that the uranium absorbed the energy of the light waves, and afterwards emitted the energy in the form of Becquerel rays. There is no doctrine in science more firmly established than that energy is neither lost nor created in any natural process, but merely changes its form, just as mechanical energy

becomes heat whenever there is friction, or chemical energy becomes energy of electric current in the case of an electric battery. Although the origin of the energy of the Becquerel rays was at first unknown, no one at that time felt any doubt as to the validity of the law of conservation of energy. It was even suggested that the atoms of uranium could catch some form of penetrating radiation which had hitherto remained undiscovered, and convert the energy of this radiation into Becquerel rays. It was natural to assume, from general experience, that the atoms of uranium, like all other atoms then known, remained constant in mass and in character, which, of course, necessitated the absorption of energy from somewhere before radiation became possible. The mystery was solved at a later time, when it was found that the atoms of uranium do not remain the same after producing radiation. In the act of emitting Becquerel rays, the atoms emit, not only energy, but part of their substance, and are so changed in character that they are no longer atoms of uranium. The energy required for radiation is therefore stored in the uranium atoms, and part of it is used in the emission of the rays; but where it originally came from to form the atom of uranium is still unknown, as the reverse process of building up atoms has never been observed. The disappearance of the uranium is so slow that it would take about 5,000,000,000 (five thousand million) years for any quantity of uranium to decay to half that quantity.

The similarity of the Becquerel rays to X-rays was suspected at an early date, so that the next step in their investigation was to find whether they produced ionization of the gas or atmosphere through which they passed (p. 202). This was found to be the case, and the ionization method turned out to be more convenient for their investigation than the photographic method. The method of the electroscope, which was used for the study of the ionization produced by X-rays, becomes now of the greatest value. There are many forms of electroscope, but one of the best

was designed by C. T. R. Wilson and is shown in Fig. 125. The case is of brass, with a glass window provided for viewing the leaf A, which is carried by a brass wire B, supported in a piece of sulphur C. Contact with the leaves for the purpose of charging them with electricity can be made momentarily by depressing the terminal J. The lower part of the brass case contains a circular opening,

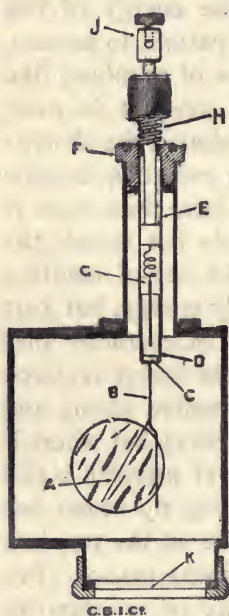

FIG. 125.—C. T. R. Wilson's electroscopes for studying radioactivity.

which may be closed by a sheet of tissue-paper K, which prevents draughts of air entering the case, but it is not thick enough to stop appreciably the entrance of any radiation entering from below.

On communicating a charge of electricity to the leaf and then watching it, the leaf will be seen to remain diverged from the fixed stem for a very long time. But if a layer of a uranium salt, such as uranium nitrate, is spread on a glass plate and placed under the aperture K, it will be observed that the leaf collapses, falling to its original uncharged position in a few minutes. The Becquerel rays emitted by the uranium can penetrate the thin membrane K and, on entering the chamber of the electroscopes, ionize the air inside. The ionization is exactly like the ionization produced

by X-rays, and the leaking away of the charge on the leaf of the electroscopes takes place in the manner already described (p. 201).

The discovery of this peculiar radiating property of uranium naturally led to a search amongst the other elements, to see whether any other substances have the same power. It was soon found by Schmidt that the element thorium emits Becquerel rays to a similar extent to uranium.

Thorium is a rare metal which is an essential constituent of incandescent gas mantles. The ionizing effect of such a mantle may easily be shown by means of the electroscope; and the photographic effect may be exhibited by placing a piece of the mantle in contact with a photographic plate in the dark for about a week. On developing the plate it is found that the parts intimately in contact with the mantle have been "exposed," and the pattern on the plate forms a very good picture of the structure of the mantle.

The chief source of uranium is the rare mineral pitchblende, which consists principally of uranium oxide. M. and Madame Curie in 1900 undertook an examination of this mineral, and found that the samples obtained from different places had differing activities as regards the emission of Becquerel rays. One specimen, obtained from Joachimstal in Bohemia, was considerably more active than pure uranium, which fact indicated the presence of some other substance in the pitchblende, of much greater activity than uranium. They therefore determined to separate the various materials constituting the mineral, a process attended by considerable difficulty. The chemical procedure will not be given here, but the result was that on separating the bismuth from the other substances it was found to present great activity, and the barium was found to be still more active. Now bismuth and barium are not active materials, that is they do not emit Becquerel rays, so that it was obvious that they were mixed with minute quantities of extremely active substances, which no chemical process would separate from them. The barium in the form of barium chloride was therefore dissolved in hot water and the solution allowed to cool until the substance in solution began to crystallize. The part which crystallized out first was found to be the most active. This part was then separated from the rest, redissolved and again crystallized. By a repetition of this process, which is called fractional crystallization, a small quantity of material was obtained practically free from barium, and its activity in

emitting Becquerel rays proved to be very great. After treating several tons of pitchblende in this way, a minute quantity of a new substance was obtained, which was found to be a million times more active than uranium. Mme Curie called the new substance **radium**, on account of its enormous radioactivity. At each stage of the process of obtaining radium chloride, as described above, the products were tested by means of the electroscope, which offered the surest guide to the presence of the radioactive material. Thus the solution of barium chloride appeared less and less radioactive, as the radium chloride was separated from it by fractional crystallization, while the parts first crystallized out, since they were richer in radium chloride than the remainder, became more and more radioactive as the process went on.

It will be remembered that the bismuth separated from the pitchblende appeared to be radioactive. By pursuing a similar process, using fractional precipitation instead of crystallization, Mme Curie obtained another radioactive substance which she named **polonium**. It was found afterwards that polonium is one of the products of radium (radium F), but it is nevertheless a distinct substance.

Subsequently, A. Debierne succeeded in separating another radioactive material from the uranium group. This he called **actinium**. It is closely associated with thorium.

Up to now we have considered the Becquerel rays as though they were of a single type, and had two properties, that of affecting a photographic plate, and that of producing ionization of a gas. In order to understand the processes of radioactivity, it is necessary to examine the nature of the Becquerel rays more closely. Our knowledge of the processes of radioactivity we owe chiefly to the work of Sir Ernest Rutherford, and a simple experiment described by him will suffice to prove the complexity of the Becquerel rays. On placing a small quantity of radium bromide below the window K of the electroscope (Fig. 125), it will be found

that the leaves collapse very rapidly, owing to the charge of electricity placed upon them escaping. This is due to the ionization of the gas by the rays from the radium, as already described. Now, a layer of tin-foil placed between the radium and the electroscope will cut off most of the rays, so that the amount of ionization is much less than before, and the leaves collapse more slowly. If they take ten times as long to collapse a certain distance it may be concluded that nine-tenths of the radiation has been cut off, only one-tenth of the original amount being able to penetrate the tin-foil. This is about the magnitude of the effect that would be observed. We should expect that a second layer of tin-foil added to the first would cut down the radiation again to one-tenth, so that it would be one-hundredth of the intensity of the original unobstructed radiation. This, however, is not found to be the case; the second layer of tin-foil produces very little reduction, showing that the rays consisted of a portion of slight penetrating power which was practically all absorbed by the first layer of tin-foil, and a second portion of much greater penetrating power which the tin-foil absorbed only slightly. The part most easily absorbable Rutherford named the α (alpha) rays. If the experiment be repeated, using sheets of lead about 2 millimetres in thickness in place of the tin-foil, a similar effect is observed, even if the α -rays have been first removed by a layer of tin-foil. It follows that the rays which penetrated the tin-foil are still complex, consisting of a portion which is almost entirely stopped by the first sheet of lead, which Rutherford called the β (beta) rays, and a still more penetrating kind which he called the γ (gamma) rays. There are thus three kinds of radiation in the Becquerel rays, called respectively the α , β , and the γ rays. The following table, given by Rutherford, shows the relative penetrating powers of the three kinds of rays:—

Rays.	Thickness of aluminium which reduces the ionization to one-half.	Relative penetrating power.
α	0.0005 centimetre	1
β	0.05 ,,	100
γ	8.0 centimetres	10,000

The α -rays have many peculiar properties: they affect the photographic plate, and they have a very powerful ionizing effect upon gases through which they pass. Also they produce fluorescence in many substances. For example, if a small quantity of radium be brought near a diamond in the dark, the diamond is seen to glow with a bluish light, which simple test serves to identify the stone as a true diamond. Very great use has been made in recent years of the fact that the α -rays from radium cause the substance zinc sulphide to glow with considerable luminosity. The radium paint which has been used for marking the points on the cards of magnetic compasses and for the points on watch dials so that they can be read in the dark, is made by mixing a small quantity of radium bromide with a considerable amount of powdered zinc sulphide. The mixture is made into a paste with a good varnish and painted on the cards, where the varnish sets hard. Unfortunately the zinc sulphide rapidly loses its power of fluorescence, and the luminosity after a year or so has fallen off considerably. On examining the luminous paint under the microscope, it will be seen that what had appeared to be a continuous luminosity really consists of a number of separate flashes, the effect looking like a very beautiful rain of sparks. Sir Wm. Crookes exhibited this effect in a little instrument which he called the spintharoscope. A minute speck of radium bromide is placed behind a thin layer of zinc sulphide which is observed by means of a high power lens. After resting the eye in the dark for a time and then looking through the lens, the brilliant flashing of sparks may be seen. There is no doubt that each flash is the result of a particle emitted by the radium

striking the zinc sulphide. It is now known that the α -rays consist of particles shot off with considerable velocity by the radium atoms, and that these α particles carry positive charges. They are atoms of the light element helium. By using considerable magnification of the zinc sulphide screen it has been found possible, by counting the flashes in a given time, to find the number of α particles emitted by radium in each second. We have already come across streams of positively charged particles in the case of the positive or canal rays in the discharge tube (p. 197). But whereas the particles in the discharge tube are atoms of the gas in the tube, the particles of the α -rays are positively charged atoms of the gas helium. This is the first case observed in which one kind of substance is produced from another, helium being produced from radium. What remains when the radium atom has lost the atom of helium will be seen later. Since the α -rays consist of rapidly moving charged particles, we should expect that they would be deflected by a magnetic field. This is the case; but owing to their mass being much greater than that of the electron (about 7400 times as great), their deflection for a given magnetic field is much less. Very strong magnetic fields are necessary in order to produce measurable deflection of the α particles, which fact has rendered the determination of their mass of considerable difficulty. Nevertheless, methods similar to those used for the measurement of the mass of the electron (p. 194) have proved successful, and the α -ray particle has been found to have the mass of a helium atom and to carry a positive charge of electricity equivalent to two electrons, but, of course, of opposite sign.

α -rays have another peculiarity, discovered by Sir Wm. Bragg, that the range throughout which they can produce ionization is strictly limited. As they penetrate, in their flight, the molecules of the gas through which they travel, they lose velocity. The fact of breaking the gaseous molecule, through which an α particle passes, involves an

expenditure of energy, so that the emergent particle has less velocity than before impact ; but, on the other hand, its own mass is considerable, so that its path is very little deflected by the impact. The paths of the α particles through air are therefore nearly straight lines. But when the velocity drops to a certain value, the power of producing ionization suddenly ceases. Thus the length of the path of an α particle through air depends upon the velocity with which it started from the radioactive material. Since this velocity is different for every material, so far as is known, and the range in air is a measure of the velocity, it follows that the range of the α particle in air serves as an excellent means of identifying the various materials from which the α particles arise ; thus, the range of the α particle in air at standard temperature and pressure is given in the table on p. 223, along with the various radioactive materials. In the case of the α particle from radium C, the range in air is 6.94 centimetres, and its velocity of emission is 192,200 kilometres per second. Sir E. Rutherford has found that when the velocity of the α particle has fallen to 11,200 kilometres per second, it ceases to have the power of ionizing the molecules of the gas, and hence it is impossible to trace it further by means of this effect.

The properties of the α particles have been exhibited by C. T. R. Wilson in a beautiful manner by allowing them to pass through air which is supersaturated with water vapour, and photographing the cloud track formed by condensation on the ions produced. Such a photograph is seen in Fig. 126 (Plate IV), from which it will be seen that the track of the α particle is nearly a straight line and so differs very much from the tortuous track of the lighter β particle. Also it will be seen that the ionization ends abruptly, the velocity having then fallen to the limit required for ionization.

The β -rays are of an entirely different character to the α -rays. They are, as we have seen, more penetrating, and it was soon discovered that they carried negative charges of electricity. This suggests a similarity to cathode rays, and



FIG. 120.—(a) Photograph by C. T. R. Wilson of the path of a beam of X-rays through air supersaturated with water vapour, showing the cathode or β -ray tracks produced. Magnification $2\frac{1}{2}$ diameters.
[From the "Proceedings" of the Royal Society.]

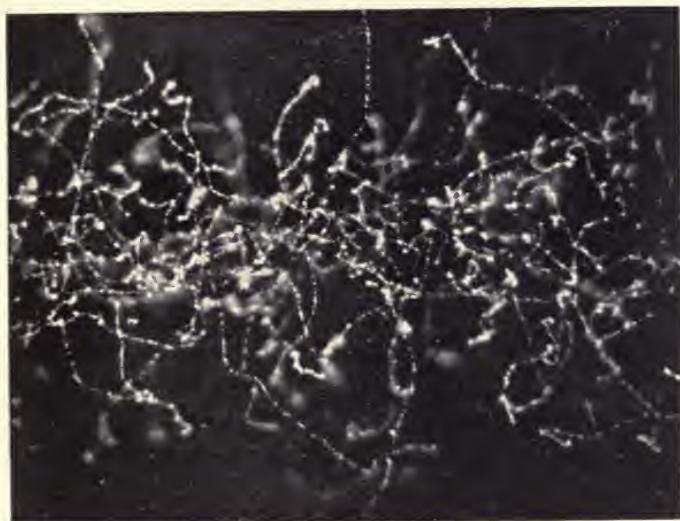

FIG. 120.—(b) Photograph by C. T. R. Wilson of the path of a beam of X-rays in air supersaturated with moisture. Magnification 6 diameters.
[From Kaye's "X-Rays."]



FIG. 126.—Photograph by C. T. R. Wilson of the track of an α particle from radium through air supersaturated with water vapour.
[From "Proceedings" of the Royal Society.]

the discovery of their deflection in a magnetic field rendered their identification an easy matter. They consist of very rapidly moving electrons, the velocity being in some cases as high as 285,000 kilometres per second, which is the nearest approach to the velocity of light, 300,000 kilometres per second, that has been observed for any moving material. An interesting point has arisen in connection with this; the electromagnetic theory shows that a charge of electricity in motion should have mass, or inertia, merely on account of its motion; but at ordinary velocities this mass is practically constant and independent of the velocity. As, however, the velocity approaches that of light, the mass of the moving charge should increase rapidly.

This has been found to be the case with the most rapid β -rays, and the observed increase in mass is quite in accord with that calculated on the assumption that the mass of the electron is of an electrical nature. This observation gives very strong support to the electromagnetic theory. An interesting application of the properties of β -rays was devised by Hon. R. J. Strutt, the present Lord Rayleigh.

A small quantity of radium bromide is contained in a sealed glass vessel A (Fig. 127), and two gold leaves in metallic contact with the interior hang from A. The whole is suspended inside an exhausted glass vessel and insulated from it. Now the β -rays, which we have seen consist of electrons, can penetrate the glass walls of A and escape, while the positively charged α -rays cannot. The result of this loss of negative electricity is that the contents of A continually accumulate positive electricity and the gold leaves diverge more and more as the charge accumulates. When, however, the leaves diverge sufficiently, the tips touch the walls of the outer vessel, which are lined with tin-foil connected to earth. This causes the instant discharge of the leaves, which therefore collapse, and the whole process begins

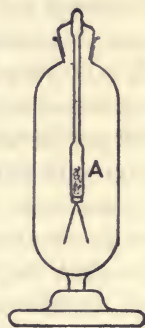

FIG. 127.—
Strutt's radium
clock.

afresh. The time that elapses depends only on the quantity of radium present and the rate of absorption of the α -rays by the walls of the vessel, so that the arrangement constitutes a sort of clock, which goes on at the same rate for an indefinite time without requiring any attention. It looks at first sight as though perpetual motion had been attained, but of course the radium is gradually being used up, and it would take 1730 years for the amount of radium to become halved.

γ -rays are in all respects similar to X-rays ; that is, they have very great penetrability, they produce ionization of gases, and affect a photographic plate. Also they are not deflected by a magnetic field. For their particular properties, therefore, the reader may consult the section on X-rays. It is of very great interest to note that the three kinds of radiation, cathode rays, positive or canal rays, and X-rays, whose existence and properties were discovered in connection with the passage of electricity through highly rarefied gases, were so soon afterwards found to be of natural occurrence in the case of radioactive substances. It is even possible that they are of universal occurrence, for there is no doubt that electrons are at least partial constituents of the atoms of all matter, while the change from one kind of atom to another, which is observed in certain cases, may have given rise to all the forms of matter of which the universe is composed, and we know that such changes are in many cases accompanied by the emission of α , β , and γ rays. In fact, it is by the emission of these rays that the transformations have been discovered.

We must now turn our attention to the transformations which have been mentioned in connection with radioactive manifestations. These were first worked out completely by Sir Ernest Rutherford for the case of thorium, but many workers have contributed to the elucidation of the changes occurring in the radioactive series of metals as at present known. Amongst these should be mentioned M. and Mme Curie, Prof. Becquerel, and Prof. F. Soddy.

Radioactive transformations, although varying greatly in the rate at which they take place, and in the character of the accompanying radiation, have one feature in common, which is, that the substance undergoing change disappears at a constant rate, and the substance produced disappears in its turn at a constant rate. To understand what this rate of decay means, suppose that half the molecules of a given substance were to change into another form, with or without the production of radiation, in say 24 hours. Only half the original quantity of substance then remains. In the next 24 hours half of this remaining quantity will change, leaving one-quarter of the original amount remaining. Thus, after the lapse of a further interval of 24 hours only one-eighth of the original amount remains, and after another 24 hours one-sixteenth, and so on. In this case it would be said that the half-value period of the substance is 24 hours. On consulting the table on p. 223 it will be seen that the half-value period of the known radioactive substances varies from 13,000,000,000 years, in the case of thorium, to 0.002 second, in the case of actinium A. The complexity of the products of any radioactive material makes the elucidation of the series extremely difficult, for the substance produced may be a solid, liquid, or gas, it may have a long life or a short one, and it may emit α -rays, or β - and γ -rays, or no rays at all, in changing to the next product of the series. Also it may remain embedded in the parent substance, or it may, in the case of a gaseous product, diffuse from it, and it may be separable from the parent substance by physical means such as heating, or by the processes of chemical analysis. In the case of radium, the immediate product is a gas which generally remains in the solid radium, though heating removes this gas, which leaves the radium pure for a short time. But immediately the production and accumulation of the gas in the radium begins to produce a fresh store. The amount of the gas which ultimately collects in the radium depends upon two things, the rate of its production by the radium, and the rate

at which the gas itself decays. It is clear that a substance which decays rapidly will never accumulate to any considerable extent, while one which undergoes very slow decay will be present in large quantities when equilibrium is eventually reached. For this reason the minerals which contain uranium and radium and their products will contain much more uranium (half-value period = 5,000,000,000 years) than radium (half-value period = 1730 years), while the gaseous product of radium (half-value period = 3.85 days) will be present in quantities too small to be detected by weighing, and only to be discovered by their radioactivity, which has an intensity corresponding to the rapidity of change. It has been found that an atom of radium in changing gives out one α particle, as does an atom of the gas produced when it, in its turn, changes. Consequently when sufficient time has elapsed for equilibrium to become established, the rate of production of the gas must equal its rate of decay, and thus the number of atoms of radium that break up in a given time is equal to the number of atoms of the gas that break up in the same time. Hence the number of α particles emitted by radium in a given time must be equal to the number emitted by the gas in the radium in the same time. Since there are, in addition, two other products of the gas which each emit an α particle for each atom breaking up, it follows that the radium only emits itself one-quarter of the number of α particles which the radium and its contained products altogether emit in the same time, provided that equilibrium has been reached. Of course, any removal of one or more of the products from the parent radium will upset the condition of equilibrium, which will only be restored by allowing sufficient time to elapse for the production of the materials removed.

	Time for decay to half-value.	Rays emitted.	Range of a particle in air at 76 cm. pressure and 15°C. in centimetres.
Uranium I . . .	5×10^9 years	α	2'50
Uranium X ₁ . .	23'5 days	β	—
Uranium X ₂ . .	1'17 min.	β	—
Uranium 2 . . .	2×10^8 years	α	2'90
Ionium	2×10^8 years (?)	α	3'00
Radium	1730 years	α	3'30
Emanation . . .	3'85 days	α	4'16
Radium A . . .	3'0 min.	α	4'75
Radium B . . .	26'8 min.	β	—
Radium C . . .	19'5 min.	α	6'94
Radium D . . .	16'5 years	β	—
Radium E . . .	4'85 days	β	—
Radium F . . .	136 days	α	3'77
Lead (?)	—	—	—
Thorium	$1'3 \times 10^{10}$ years	α	2'72
Mesothorium 1	6'7 years	β	—
Mesothorium 2	6'2 hours	β, γ	—
Radiothorium .	1'9 years	α	3'87
Thorium X . . .	3'64 days	α	4'30
Emanation . . .	54 sec.	α	5'00
Thorium A . . .	0'14 sec.	α	5'70
Thorium B . . .	10'6 hours	β	—
Thorium C . . .	60'8 min.	α	4'95
Thorium D . . .	3'1 min.	β	—
Thorium C ₂ . .	$1/10^{11}$ sec.	α	8'60
Protoactinium .	—	α	3'14
Actinium	about 20 years	—	—
Radioactinium.	19'5 days	α	4'60
Actinium X . . .	11'6 days	α	4'40
Emanation . . .	3'92 sec.	α	5'70
Actinium A . . .	0'002 sec.	α	6'50
Actinium B . . .	36'1 min.	β	—
Actinium C . . .	2'15 min.	α	5'40
Actinium D . . .	4'71 min.	β	—

It is impossible to give in the present book an account of all the methods of experiment which led to our knowledge of the radioactive series of elements, but an outline of these series is attempted. There are three such series known, but for a long time there were considered to be four. The uranium series and the radium series were discovered separately, and although it was suspected that

radium was one of the products of uranium, its descent was not definitely traced. The constancy of the proportion of the quantity of radium to that of uranium in certain minerals was considered evidence that the latter was the origin of the former, but we now know, beyond doubt, what changes occur which link the two together. The uranium-radium series is the most important of all the radioactive series, containing about sixteen distinct substances. The other two are the thorium series and the actinium series (p. 223).

Uranium is the heaviest substance known, its atomic weight being 238.5. It occurs in many minerals, particularly in pitchblende. The salts of uranium are generally yellow or greenish, the substance being used in the manufacture of canary glass. All the salts are radioactive, that is, they will affect a photographic plate and will produce ionization. Sir William Crookes found, in 1900, that on adding ammonium carbonate to a solution of a salt of uranium, a precipitate is formed which dissolves on adding more ammonium carbonate. On filtering the solution, a minute precipitate is separated from it. This precipitate has a powerful effect upon the photographic plate, and the original uranium has lost this power. On the other hand, the production of ionization is still retained by the uranium. Since the photographic effect is chiefly due to β -rays and the ionizing effect to α -rays, it follows that the substance separated from the uranium emits β -rays. Sir William Crookes called this substance uranium X. It follows that uranium in changing to uranium X emits α -rays, while the uranium X emits β -rays. After the lapse of two or three months the uranium recovers its photographic effect owing to the production of a fresh supply of uranium X, while the separated uranium X entirely disappears. It has since been found that uranium X is not a simple substance. Uranium itself produces uranium X₁, with emission of one α -ray particle. Uranium X₁ has a half-value period of 23.5 days, changing to uranium X₂ with emission of slowly moving electrons. The half-value period of uranium X₂ is only

117 minutes, and it emits β -rays, changing to a very long-lived product called uranium 2, whose half-value period is two million years, which emits one α -ray particle, changing to a substance called ionium, whose half-value period is two hundred thousand years. Ionium is the parent of radium, and each atom of ionium emits an α particle in the act of becoming an atom of radium. Thus each atom of uranium emits in all three α particles before it becomes one radium atom. Now the atomic weight of uranium is 238.5, and the α particle is really an atom of helium, which has an atomic weight of 3.99. Thus the loss of three α particles should lessen the atomic weight of uranium by $3 \times 3.99 = 11.97$, or very nearly 12, and it then becomes 226.5. This is the atomic weight found by direct measurement for radium, which fact is very good evidence in favour of the truth of the deductions made from observations on radioactivity. The β -ray particles, or electrons lost in the radioactive changes, are of such small mass that their effect on atomic weight is negligible.

Radium and its immediate changes presents one of the most important and fascinating chapters in the history of science, being found as the result of deliberate search by Mme Curie, and producing the most striking series of products. It has already been mentioned that radium continuously produces a gas, the radium itself having a half-value period of 1730 years, and emitting α -rays during the change. The gas is called radium emanation, which itself has a half-value period of 3.85 days, and also emits α -rays during its change. Radium emanation obeys the ordinary laws of gases, and liquefies at a temperature of -65° C. Its atomic weight is 223, which corresponds very well with that of radium, assuming that each radium atom (226.5) loses an α particle (3.99) in becoming an atom of radium emanation.

Under no known conditions can the rate of change or the activity of a substance be varied; radioactive changes go on at the same rate at the lowest and highest temperatures,

whether the substance is in chemical combination with another or not, whether it is compressed or rarefied. It was at first thought that radium emanation exhibited an exception to this rule, for on immersing a solid, such as a metal rod, in the emanation for an hour or so, and then withdrawing it, the rod was found to effect an electroscope and exhibit all the properties of a radioactive substance. If the rod be negatively charged with electricity, the excited activity is greater than that upon an uncharged rod. Also the excited activity can be removed by scraping off the surface of the rod, which shows that the rod has not become radioactive, but that a radioactive substance has been deposited upon it. The atoms must have positive charges, since they are attracted to a negatively charged rod. The substance deposited was called the active deposit, but it was soon seen that it is not a simple substance. The activity of the active deposit falls to a very small quantity in the course of a day, leaving a minute remainder which increases in activity over several years. Three changes are involved in the rapid part of the decay, the first occurring with emission of α -rays and having a half-value period of three minutes. The substance is called radium A and is the immediate product of the emanation. The product of radium A is called radium B, which has a half-value period of 26.8 minutes and emits slowly moving electrons, and gives rise to radium C, having a half-value period of 19.5 minutes, in turn becoming radium D, with emission of α - and β -rays. Radium D is a long-lived product and emits slowly moving electrons and having a half-value period of 16.5 years. Radium E has a half-value period of 4.85 days, and also emits slowly moving electrons, while the next product, radium F, emits α -rays and has a half-value period of 136 days. Radium F is a substance of considerable interest, because it was discovered independently by Mme Curie, who called it polonium (p. 214), and also because it is the last of the radioactive products of the uranium-radium series. The atom of radium, with its products, thus loses

five α particles in the various transformations, so that the atomic weight of the ultimate product would be $\{226.5 - (5 \times 3.99)\}$, that is 206.7. The atomic weight of lead is 207, which fact suggests that the product of change of radium F is lead. The presence of lead in all the uranium-radium minerals confirms this fact; but so far as is known, lead is not radioactive and is certainly an extremely long-lived substance. Since lead does not emit α , β , or γ rays, its change could only be detected by the loss in weight in lead, which is certainly not within the range of experimental detection. There is no reasonable doubt that lead is the product of radium F, and therefore the end product, so far as is known, of the uranium-radium series.

The thorium and the actinium series do not present the special features of interest of the uranium-radium series. A table of the radioactive changes at present known is given on p. 223.

One of the most interesting facts in connection with radioactivity is the production of heat during radioactive change. The α and β particles are ejected from the atoms with enormous velocities, which in itself indicates a great store of energy in each atom. Owing to the greater size of the α particle, more energy is required to give it its great velocity than in the case of the β particle, and the loss of energy of the atom in ejecting an α particle is probably about ten times that for a β particle. If the α particles are stopped by collision with the atoms in the interior of the radioactive body, heat is produced, and this heat causes a rise of temperature. It follows that radioactive bodies, unless in very thin layers, are always at a higher temperature than their surroundings, which difference in temperature amounts to several degrees in the case of radium compounds. The energy of the α particle has its counterpart in the recoil of the remainder of the atom. If an α particle, whose mass is approximately that of 4 hydrogen atoms, is shot out with velocity of, say, 20,000 kilometres per second from an atom of radium of mass 226, the

velocity of recoil of the atom can be calculated just as in the case of the velocity of recoil of a gun when the bullet leaves it. Thus, $4 \times 20,000 = 226 \times (\text{velocity of recoil})$, so that the velocity of recoil is 354 kilometres per second. It follows that the energy or heating effect of the α particle is about 57 times that of the recoil atom, and the latter must be added to the former to obtain the whole heating effect. The rate of emission of heat by radium and its products has been measured in several ways, and the results compare very well with those found by calculating the energy liberated when the α - and β -rays are given out. It has been found that the heat emitted by 1 gramme of radium and its short-lived products, the emanation and radium A, B, and C, is enough to raise about $1\frac{1}{4}$ gramme of water from freezing point to boiling point in every hour. Considering that the radium continues to give out this heat hour after hour, for hundreds of years, without appreciable diminution, it will be realized that in the radium atoms there must be a vast store of energy. Even when all the radium has changed through the whole chain of products and become lead, it is almost certain that the store of energy in the atom is not much diminished, although there are no means of observing any further changes that may occur. There is no reason to believe that the atoms of the known radioactive materials differ in character from those of other materials, except in the fact that the atoms are less stable and are apt to give off an α or a β particle with alteration to a new internal arrangement. It is probable that every atom contains a heavy central portion with lighter outer portions in rapid rotation round it, in a manner somewhat similar to the solar system of a central sun with planets revolving around it. Some arrangements are possible, others impossible, but some of the possible arrangements are less stable than others. When they are of an unstable form, rearrangements are frequent, as in the case of the short-lived radioactive substances. But with greater stability of form, changes are less frequent, and the

substance has a longer life. The ordinary elements constitute the more stable forms, and in the majority of cases the stability is so great that no change has been observed. In the whole life of a gramme of radium, which of course lasts over millions of years, it has been estimated that the total amount of heat given out is enough to raise 37,000 kilogrammes of water from freezing to boiling point. The vastness of the store of energy in the radium may be realized by remembering that the most violent combustion, that of hydrogen and oxygen to form water, gives an amount of heat which is insignificant in comparison with that given out by radium in the whole of its radioactive changes. For the formation of one gramme of water by the combustion of hydrogen in oxygen causes an evolution of only enough heat to raise about one-third of a kilogram of water from freezing to boiling point. Hence the store of energy in a given weight of fuel is almost nothing in comparison with the store of energy within the atoms. There is no means at present known of affecting the rate at which radioactive changes proceed, and their rate is in all known cases so slow that the heat evolved is of no practical service. But the dream of the physicist is to discover some method of accelerating the process of radioactivity, and to make the atoms of ordinary substances give up their energy at will. This would liberate stores of energy, compared with which our present supplies of fuel are infinitesimal, and would render us independent of coal.

Many speculations as to the source of energy of the sun have been made at different times, and the explanations given are undoubtedly in part true. But the tremendous store of energy within the atoms themselves had played no part in these explanations until recent years. That radioactive changes are occurring in materials present in the sun is extremely probable, for the element helium is present in the sun's atmosphere, in fact, it was discovered there before it was known that it existed on the earth, and we have seen that helium is given off as α particles during many

radioactive processes. Another interesting speculation on which our knowledge of radioactivity has shed important light, is that respecting the age of the earth. For many years geologists had maintained, from the examination of fossils, that the age of the earth was much greater than the estimate made by physicists from the known rate of cooling. Treating the earth as a mass of hot material which is cooling by radiating its heat into space, the time that has elapsed since its temperature was first within the limits required for living organisms has been found. But if there is another store of energy, as we see there is in the motions going on within the atoms, it is likely that the time to cool is much greater than was at first thought. It was estimated by Prof. Strutt, now Lord Rayleigh, that about 270 tons of radium in the interior of the earth would produce heat at a sufficient rate to account for the known increase of temperature of 1° C. for every 100 feet depth in the outer layers of the earth. On observing the radium contents of known minerals, it is seen to be not unlikely that such a quantity of radium exists in the earth, so that the rate of cooling of the earth is certainly much slower than was at first thought. The latest estimates of the time for which the earth has been habitable come much nearer the thousand million years required by the geologists than the earlier estimates.

ELECTRICAL TERMS IN GENERAL USE

α -rays.—The most readily absorbable part of the rays emitted by radioactive substances. They have positive charges, and eventually prove to be positively charged atoms of helium.

Accumulator.—*See* Secondary cell.

Aerial.—The vertical conductor in which electrical oscillations occur, and from which the electromagnetic radiations used in wireless telegraphy take their rise.

Alternating current.—Current which flows alternately in opposite directions through any circuit. The number of cycles of current per second is called the frequency, and varies in common practice from 25 to 100.

Ampere.—The practical unit of electrical current. It is the current which, flowing in an arc of a circle of unit length and unit radius, causes magnetic field of one-tenth of a unit strength at the centre. Also 1 ampere flowing for 1 second deposits 0.001118 gramme of silver or 0.000329 gramme of copper.

Amplifier.—*See* Triode.

Anode.—The electrode by which the current enters the electrolytic cell.

Arc.—The phenomenon exhibited when a current passes continuously across a conducting bridge of gas between two conductors, generally of carbon.

Armature.—The rotating portion of a dynamo, in which the current is produced. Also, a piece of iron placed near the poles of a magnet.

Audion.—*See* Triode.

Automatic telegraphic working.—A method of sending the message by mechanical means instead of working the sending key by hand.

- β -rays.**—Rays emitted by radioactive substances consisting of electrons possessing very high velocity. They are of the same nature as the cathode rays of the discharge tube.
- Battery.**—A number of cells so placed in a circuit that their effect is cumulative. The earliest example of a battery is the Volta pile.
- Becquerel rays.**—The rays emitted by uranium and other radioactive substances. These are now known by the names of their constituents, the α -, β -, and γ - rays.
- Board of Trade unit.**—See Kilowatt-hour.
- Bus bars,** or omnibus bars, are thick copper bars provided with terminals and mounted on insulating supports. The supply mains are joined, one to each bus bar, and the separate distribution mains are similarly joined to the two bars.
- Canal rays.**—Streams of positively charged atoms which have passed through apertures in the cathode of the discharge tube.
- Cell.**—The electric cell is an arrangement of conductors and liquids which produces electric current from the energy of the chemical reactions occurring.
- Coherer.**—A loose metallic contact or series of contacts, which falls in resistance when minute electric currents pass through it, thus forming a delicate detector for electromagnetic waves.
- Commutator.**—An apparatus for changing the direction of an electric current in a circuit in an appropriate manner.
- Condenser.**—A conducting sheet of considerable extent, parallel to and insulated from a similar sheet. The great area required is usually obtained by using alternating layers of tin-foil for the conducting sheets, the layers being separated by paraffined paper or, in the best condensers, thin sheets of mica.
- Conductor.**—A substance which will carry an electric current. All metals and some other substances are conductors.
- Coulomb.**—The practical unit of quantity of electricity. It is the quantity of electricity which flows through a conductor when a current of one ampere flows for one second.
- Crater.**—The hottest part of the positive carbon when the arc is formed. It is cup-shaped owing to the rapid volatilization of carbon at the high temperature.
- Crookes dark space.**—The dark space immediately surrounding

the kathode of the discharge tube, and separating it from the kathode glow.

Crystal detector.—A rectifier which produces its effect by allowing the current through the contact of a crystal (generally carborundum) and a metal to pass more freely in one direction than in the other.

Declination, magnetic.—The angle between the rest position of the magnetic compass and the true north-and-south direction.

Diamagnetic.—A term applied to those substances which when placed in a magnetic field are urged from the stronger to the weaker parts of the field. Among diamagnetic substances are bismuth, antimony, water, silver, gold, sulphur, etc.

Dielectric.—*See* Insulator.

Differential galvanometer.—A form of galvanometer in which there are two coils, similar in all respects, so that when the same current passes in opposite directions round the two coils, it produces no effect upon the needle.

Differential system.—A form of duplex telegraphy in which the working is effected by the use of differential galvanometers.

Diplex system.—A system of working in which two messages may be sent simultaneously in the same direction along a line, by using relays of different types for receiving the message.

Direct current.—Current which flows always in the same direction.

Dry cell.—A cell in which the electrolyte is held in sawdust and glycerine for the prevention of splashing.

Duplex system.—A system of telegraphy in which messages may be sent in either direction along a line at the same time without interfering with each other.

Dynamo.—A machine for the conversion of mechanical motion into electric current.

Earth.—A connection to the ground for the purpose of completing an electric circuit through the earth in order to save one connecting line.

Electro-chemical equivalent.—The amount of any substance liberated from solution by one ampere flowing for one second.

Electrode.—The conductor by which the current enters or leaves an electrolyte.

Electrolysis.—The process of passage of an electric current

through certain solutions, accompanied by a decomposition of the substance in solution.

Electrolyte.—The solution through which a current passes, with decomposition of the substance in solution.

Electro-magnet.—An iron core, surrounded by a coil of wire carrying an electric current and magnetized by it. The core is magnetized only when the current flows in the coil.

Electromotive force (e.m.f.).—The property of the source of current in a circuit which determines the current and rate of production of electrical energy in the circuit. Whenever energy can be converted from some other form into energy of electric current, there an electromotive force is situated. (*See Volt.*)

Electron.—The ultimate unit part of negative electricity, first discovered in motion as the kathode rays, but now found to be present in the atoms of all matter. The electron theory is the most fruitful of all modern electrical theories. The mass is 8.9×10^{-28} gramme or $\frac{1}{1836}$ of the mass of the hydrogen atom.

Electrostatics.—The study of the properties of electricity at rest.

Faraday dark space.—The dark space or gap between the kathode glow and the positive column in a discharge tube at partial vacuum.

Ferro-magnetic.—A term applied to the three metals—iron, nickel, and cobalt—which have magnetic properties which are several thousands of times greater than those of any other known substances.

Field magnet.—A powerful electro-magnet employed to supply the magnetic field in which the armature of a dynamo or electro-motor rotates.

Flame arc.—An arc lamp in which the carbons are impregnated with various mineral substances which volatilize and emit light when incandescent. The long arc has thus the appearance of a flame.

Flashing.—A process in the manufacture of carbon filament lamps, in which the filament is rendered uniform, of correct resistance and of good surface.

Frequency.—The number of complete vibrations made in one second.

γ -rays.—The most penetrating rays emitted by radioactive substances. They are of the same character as X-rays.

- Galvanometer.**—An instrument for detecting or measuring small electric currents.
- Incandescent lamp.**—A lamp in which a fine filament is raised to such a high temperature by the passage of an electric current that light is emitted.
- Induction coil.**—A type of transformer in which the interruption of a current from a few cells in the primary circuit causes an enormously great electromotive force in the secondary circuit. Various devices are used to produce the repeated interruption of the primary current, the most common type being of the trembler pattern.
- Induction motor.**—An alternating current electro-motor in which a rotating magnetic field causes a copper conductor mounted on an axle to follow the rotation of the field. Such a motor is not confined to one speed of rotation as is the case with the synchronous motor.
- Insulator.**—A substance such as amber, quartz, paraffin wax, silk, etc., which will not convey an electric current.
- Ionization.**—The effect of rendering a gas a conductor of electricity by the passage of rays through it. The ionizing rays may be X-rays, α -rays, β -rays, or γ -rays.
- Ions.**—The name "ion" is generally applied to a charged particle of a gas when the gas is at ordinary pressure. Both electrons and the positive nuclei of atoms gather neutral atoms about them, and the collection if arranged about a positive charge will be driven in one direction, if about a negative charge or electron in the opposite direction by an electric field. Ions also occur in electrolysis.
- Isotopes.**—Varieties of atoms of an element having atomic weights usually differing by 2.
- Kathode.**—The electrode by which the current leaves the electrolytic cell.
- Kathode glow.**—The first luminous tract on proceeding outwards from the kathode of the discharge tube. It is bounded by the Crookes dark space on one side and the Faraday dark space on the other.
- Kathode rays.**—Rays in the Crookes dark space, proceeding outwards from the kathode of the discharge tube. They were eventually found to consist of streams of electrons travelling with high velocity.
- Kilowatt-hour.**—The Board of Trade unit of electrical energy.

- It is the energy supplied in one hour by a power of 1000 watts.
- Lead.**—Any wire or cable leading the current to or from the place at which it is required.
- Leyden jar.**—A convenient form of condenser, made of a glass jar with inner and outer coatings of tin-foil.
- Magnet.**—A piece of iron or steel which has the property of attracting other pieces of iron or steel, and also the property of setting in one definite direction when free to turn.
- Magneto.**—A rotating form of induction coil in which the current in the primary coil is produced as in the dynamo, by rotating a coil of wire in a magnetic field. The spark in the secondary circuit is commonly employed for exploding the gaseous mixture in the cylinder of the internal combustion engine.
- Microphone.**—An arrangement by which small mechanical movements such as sound waves produce comparatively large variations in electric current. The commonest type of microphone makes use of the varying resistance of carbon contacts due to mechanical disturbance.
- Motor-generator.**—A combination of electro-motor and dynamo in which the former drives the latter. The armatures are usually mounted on the same axle. The motor-generator is most commonly used when the supply is alternating and the requirement is for direct current. The electro-motor is then of the alternating-current type and this drives a direct-current dynamo.
- Multiplex system.**—A system of telegraphy in which more than four messages may be sent over the same line at the same time.
- Nodon valve.**—An electrolytic cell in which the current will only pass in one direction. It is used for converting an alternating current into a unidirectional current. It cannot, of course, correct for the fluctuations in value of the alternating current.
- Ohm.**—The practical unit of electrical resistance (*see* Volt). The ohm is the resistance of a column of mercury 106.300 centimetres long and weighing 14.4521 grammes when the temperature is 0° C.
- Paramagnetic.**—A term applied to those feebly magnetizable substances which when placed in a magnetic field are urged

from the weaker to the stronger parts of the field. Among paramagnetic substances are platinum, aluminium, and many minerals containing iron.

Polarization.—The deleterious effect of hydrogen deposited upon the positive electrode of a cell when producing current.

Pole (magnetic).—The place on a magnet where the external properties of the magnet are most strongly exhibited.

Polyphase current.—Alternating current in three or more connected circuits in which the simultaneous currents are not in the same phase.

Positive rays.—*See* Canal rays.

Primary cells.—Cells in which the energy required for the maintenance of the electric current is derived from the chemical reactions between the substances of which the cell is constructed. A primary cell is useless when once its constituent materials are used up.

Primary coil.—The term is usually applied to one coil of a transformer or induction coil. It is the coil through which the current passes which is due to some outside source of electromotive force. The result of variation in the strength of current in the primary coil is to produce an electromotive force in the secondary coil. (Also *see* Transformer.)

Quadruplex system.—A system of telegraphy in which four messages may be transmitted simultaneously over the same line, two in each direction.

Radioactivity.—The power of emitting spontaneously rays which affect the photographic plate and produce ionization of gases. The radioactive substance loses part of its mass, becoming a new chemical substance, in the act of emitting the rays.

Receiver.—The part of a telephonic installation which converts variations of electric current into sound waves.

Rectifier.—An arrangement for enabling a rapidly oscillating current to be detected by means of the telephone receiver. It either suppresses entirely the half-wave of current in one direction, or in some cases, allows the half-wave in one direction to be transmitted much more readily than the half-wave in the other direction.

Relay.—An electro-magnet or other device by means of which a feeble incoming current or set of waves sets in operation some local source of power and so magnifies the original feeble signal.

- Resonator.**—A conductor for which the natural frequency of electrical oscillation is the same as that of the waves falling upon it.
- Rheostat.**—A conductor placed in a circuit for the purpose of regulating the current. Its resistance is not generally known with accuracy.
- Rotor.**—The rotating part of an alternating-current dynamo or motor.
- Secondary or storage cells.**—Cells in which the energy required for the current is put into the cell by passing a current through it. A secondary cell may be charged and discharged an indefinite number of times.
- Secondary coil.**—*See* Transformer and Primary coil.
- Selenium cell.**—A thin layer of selenium whose resistance varies when the intensity of light falling on it changes. It enables variations in intensity of a beam of light to be detected by the telephone.
- Series dynamo.**—A dynamo in which the armature, the field coils, and the external circuit are in series so that the main current, in passing round the field coils, magnetizes the core of the field magnet.
- Series, in.**—A term applied to the conductors when the same current flows through them all in turn.
- Short-circuit.**—A conductor of low resistance placed in parallel with any part of an electric circuit, so that by taking practically the whole current it cuts out this part of the circuit.
- Shunt dynamo.**—A dynamo in which the current from the armature divides between the field coils and the external circuit, part flowing through each.
- Siphon-recorder.**—A delicate suspended coil galvanometer with inking arrangement, used for receiving and recording the feeble signals transmitted by a submarine telegraph cable.
- Stator.**—The fixed part, either armature or field magnets, of an alternating-current dynamo or motor.
- Step-down transformer.**—A transformer in which the secondary electromotive force is lower than the primary electromotive force.
- Step-up transformer.**—A transformer in which the secondary electromotive force is higher than the primary electromotive force.
- Synchronous motor.**—An alternating-current electro-motor in

which the speed of rotation must always be such that the supply current is always in the same phase with respect to the position of the rotor coils as the current produced when running as an alternating-current dynamo. A synchronous motor will therefore only run at one speed on any given alternating-current supply.

Thermions.—The electrons emitted by bodies at high temperature.

Three-wire system.—A system of supply of direct current in which an economy in mains is effected by using two parallel circuits in which the return current in one is the outgoing current of the other.

Transformer.—An apparatus consisting of a primary and a secondary coil wound upon the same iron core, so that variations of current in the primary, cause electromotive forces in the secondary. In a “step-up” transformer the secondary has more turns than the primary. In a “step-down” transformer the primary has more turns than the secondary. In wireless telegraphic practice the iron core is frequently absent.

Transmitter.—The part of a telephonic installation which converts sound waves into variations of electric current.

Triode.—A vacuum tube having three electrodes. One is an incandescent filament of tungsten; the second is a wire gauze or grid; and the third is a plate. If a considerable electromotive force acts from the plate to the filament, the current in the plate circuit is profoundly modified by even small variations in electromotive force between the grid and the filament. Hence the name amplifier or amplifying valve as frequently applied to the triode.

Volt.—The practical unit of electromotive force, derived from the rate of working in a circuit when unit current is flowing. Where the e.m.f. (E) is in volts, the current (I) in the circuit in amperes and the resistance (R) in ohms—

$$E = I \times R$$

(See Electromotive force.)

Voltmeter.—A piece of apparatus for measuring the value of a current by means of the amount of substance liberated by it electrolytically.

Watt.—The unit of power, or rate of working. Thus—

$$\text{Watts} = \text{volts} \times \text{amperes.}$$

Wattmeter.—An instrument which measures the power supplied to a circuit directly in watts, thus obviating the necessity for measuring the current and electromotive force separately.

Wheatstone's bridge.—An arrangement of four conductors such that a current sent in at one corner of the arrangement and out at the opposite corner will not affect a galvanometer placed between the remaining two corners. If the four conductors have resistances R_1 , R_2 , R_3 , and R_4 , then for the Wheatstone condition to be fulfilled

$$R_1 : R_2 :: R_3 : R_4.$$

X-rays.—Rays emitted by atoms of matter when struck by rapidly moving electrons. They were discovered by Röntgen, and are sometimes called Röntgen rays. He found them to be emitted when kathode rays fall upon solid materials.

INDEX

A

α -rays, 215, 231
 Abney, Sir William, 84
 Accumulators, 136, 141, 231
 Actinium, 214
 Aerial, 158, 183, 231
 Aeroplane compass, 12
 Æther, 149
 Aircraft wireless, 186
 Airy, 10
 Alexander, E. F. W., 164
 Allen, N. A., 85
 Alternating current, 51, 231
 Alternator, 64
 Ampère, André M., 19, 145
 Ampere, the, 231
 Amplifying valve, 175, 231
 Anode, 14, 231
 Antenna, 162, 183
 Arago, 67
 Arc, electric, 81, 231
 —, enclosed, 88
 —, flame, 89
 —, Poulsen, 166
 —, "singing," 166
 — lamp, automatic, 87
 Armature, 22, 34, 231
 Arrhenius, Svante, 129
 Aston, F. W., 198
 Atlantic cable, 106
 Atmospheric disturbances, 183
 Attenuation, 182
 Audion, 175, 231
 Automatic arc lamp, 87
 — telegraph, 101, 231
 Ayrton, Mrs., 85

B

β -rays, 215, 218, 232
 Baudot, 104
 Becquerel, H., 209, 220
 Becquerel rays, 210, 232
 Bell, Alexander Graham, 110

Bell, electric, 25
 — receiver, 113
 — telephone, 111
 Board of Trade unit, 48, 232
 Bragg, Sir W. H., 208, 217
 Brake, electric, 22
 —, motor, 44
 Branly coherer, 168
 Bremer, 89
 Brown loud speaker, 116

C

Cable, Atlantic, 106
 —, submarine, 108
 Cadmium cell, 139
 Canal rays, 197, 232
 Carbon filament, 76
 — microphone, 113
 Carbons, cored, 84
 Carbone arc, 88
 Carlisle, Anthony, 14, 125
 Cascade, triodes in, 178
 Cathode. *See* Kathode
 Cell, cadmium or Weston, 139
 —, dry, 141
 —, selenium, 186
 Cells, primary, 136, 232
 —, secondary, 136
 —, storage, 136, 141
 Clocks, electric, 23
 Cloud formation, 196
 Coherer, 169, 232
 Coil, induction, 52
 —, primary, 53
 —, secondary, 53
 Coils, loading, 123
 Commutator, 33, 232
 Compass, aero, 12
 —, Kelvin, 11
 —, magnetic, 3, 8
 Condenser, 55, 150, 232
 Conduction, electric, 196
 Conductors, 16, 232
 Cooke, 91
 Coolidge tube, 206

Copper refining, 133
 — voltameter, 131
 Cored carbons, 84
 Coulomb, the, 126, 232
 Cowper-Coles, S., 133
 Crater, 83, 232
 Crookes dark space, 191, 232
 Crookes, Sir William, 191, 216, 224
 Crystal detector, 173, 233
 Crystals and X-rays, 208
 Curie, Mme, 213, 219
 Curie, P., 28, 213, 219
 Current, alternating, 51, 231
 —, direct, 50
 Currents, induced, 31

D

Damped oscillations, 163
 Daniell's cell, 138
 Dark space, Crookes, 191
 Davy, Sir Humphry, 15, 81, 125
 Debiere, A., 214
 Declination, magnetic, 9, 233
 de Forest, L., 175
 Detector, crystal, 174
 —, magnetic, 170
 Diamagnetic, 28, 233
 Dielectrics, 15, 233
 Differential system, 97, 233
 Diplex telegraph, 99, 233
 Direct current, 50, 233
 Direction finding, 184
 Discharge of condenser, 151
 Distortion, 119, 182
 Disturbances, atmospheric, 183
 Dry cell, 141, 233
 Duddell, 165
 Duplex telegraph, 97, 233
 Dynamo, 34, 233

E

Earth, the, as a magnet, 9
 — return, 92, 117, 233
 Earth's magnetic poles, 9
 Economizer, 89
 Edison, 75, 76, 143
 Electric arc, 81
 — bell, 25
 — brake, 22
 — clocks, 23
 — tuning-fork, 26
 Electro-chemical equivalent, 130, 233
 Electrodes, 14, 233
 Electrolysis, 14, 233
 —, Faraday's laws of, 126

Electrolyte, 14, 234
 Electro-magnet, 21, 27, 234
 Electromagnetic theory, 148
 Electromotive force, 30
 Electro-motor, 41
 Electron, 194, 234
 Electroplating, 15, 132
 Electroscopes, 200, 212
 Electrostatics, 17, 234
 Electrotyping, 134
 Emanation, radium, 225
 Enclosed arc, 88
 Equivalent, electro-chemical, 130
 Ewing, Sir J. A., 20

F

Faraday dark space, 190, 234
 —, Michael, 6, 30, 53, 125, 145
 Faraday's laws of electrolysis, 126
 Faure, 142
 Feddersen, 152
 Ferromagnetic, 27, 234
 Field magnet, 34, 234
 Filament, carbon, 76
 —, metal, 79
 Flame arc, 89, 234
 Flashing, 77
 Fleming, J. A., 165, 174
 Forming, 142
 Forrest, 85
 Frequency, 119

G

γ -rays, 215, 220, 234
 Galvani, Luigi, 4
 Galvanism, 4
 Galvanometer, 18, 235
 —, suspended coil, 95
 Gas-filled lamps, 80
 Geissler tubes, 191
 Gilbert, William, 3, 8
 Glow, cathode, 190
 Gold leaf electroscope, 200
 Goldschmidt, R., 164
 Goldstein, 197
 Grove, Sir W., 141

H

Half-watt lamps, 80
 Heat due to radioactivity, 227
 "Heaviside layer," 184
 —, Oliver, 122
 Helium, 217
 Henry, Joseph, 145

Hertz, H., 153, 191
 Hittorf, W., 129
 Hope Jones, F., 24
 Hughes, D. E., 112
 Hughes telegraph, 91, 103

I

Incandescent lamps, 74, 235
 Induced currents, 31
 Induction coil, 52, 235
 — motor, 67, 70, 235
 Infra-red, 160
 Inker, Morse, 94
 Insulators, 15, 235
 Ionium, 223
 Ionization, 199, 235
 Ions, 202
 Isotopes, 198, 235

J

Jablochkoff's candles, 85
 Jack and plug, 118

K

Kathode, 14, 235
 — glow, 190, 235
 — rays, 192, 235
 Kelvin compass, 11
 —, Lord, 10, 47, 91, 95, 107, 122,
 150, 203
 Key, Morse, 93
 Kilowatt-hour, 98, 235

L

Lamps, incandescent, 74
 Laue, M., 208
 Leclanché cell, 140
 Leyden jar, 152, 236
 Lines of force, magnetic, 7, 146
 Loading coils, 123
 Lodestone, 1, 3, 6
 Lodge, Sir Oliver, 154, 169
 Loud speaker, Brown, 116

M

Magnet, field, 34
 Magnetic compass, 3, 8
 — declination, 9
 — detector, 170

Magnetic lines of force, 7, 146
 — poles, 6
 — separator, 29
 Magnetite, 3
 Magneto, 70, 236
 Marconi, G., 158, 169
 Maxwell, James Clerk, 147
 Metal filament, 79
 Microphone, carbon, 113, 236
 Millikan, 194
 Mitchell, John, 6
 Morse code, 92
 — inker, 94
 — key, 93
 Motor brakes, 44
 Motor-generator, 36, 236
 Motor, induction, 67, 70
 —, synchronous, 66
 Multiplex telegraph, 100, 236
 Murray printing telegraph, 104

N

Newton, Sir Isaac, 160
 Nicholson, William, 14, 125
 Nodon valve, 144, 236

O

Oersted, Hans C., 13, 91
 Ohm, the, 236
 Oscillatory discharge of condenser,
 151
 Osmium, 79
 Osram lamps, 79

P

Parallel, in, 46
 Paramagnetic, 28, 236
 Perigrinus, Peter, 6
 Pile, voltaic, 5
 Planté, 141
 Plug, jack and, 118
 —, sparking, 72
 Poisson, 10
 Polarization, 138, 237
 Poles, magnetic, 6, 237
 Polonium, 214
 Poulsen arc, 166
 Power, 51
 Primary cells, 136, 237
 — coil, 53, 237
 Printing telegraph, 104
 "Pupin" coils, 124
 —, M. I., 123

Q

Quadruplex telegraph, 99, 237
 Quenched sparks, 164

R

Radiation, 157
 Radium, 214
 —, clock, 219
 —, emanation, 225
 Railway telegraphic receiver, 95
 Range of a particle, 218
 Rankine, A. O., 186
 Rayleigh, Lord, 115, 130
 Rays, α -, 215, 231
 —, β -, 215, 218, 232
 —, Becquerel, 210
 —, canal, 197
 —, γ -, 215, 220
 —, kathode, 192
 —, X-, 199
 Receiver, Bell, 113, 237
 —, railway telegraphic, 95
 —, telephone, 112
 Recoil of atom, 227
 Recorder, siphon, 95
 Rectification, 172, 237
 Refining, copper, 133
 Relay, 94, 237
 Rheostat, 42, 238
 Richardson, O. W., 206
 Righi, A., 167
 Röntgen, Prof., 199
 Ross, Sir James, 9
 Rotor, 65, 238
 Rowland-Wetherill, 28
 Rutherford, Sir Ernest, 170, 214, 220

S

Schmidt, 212
 Secondary cells, 136, 141, 238
 —, coil, 53, 238
 Selenium, 186, 238
 Separator, magnetic, 29
 Series dynamo, 35, 238
 —, in, 45, 238
 Shackleton, Sir Ernest, 9
 Shunt, dynamo, 35, 238
 Sidgwick, Mrs., 130
 Silver voltmeter, 131
 Simple voltaic cell, 136
 Singing arc, 166
 Siphon recorder, 95, 238
 Soddy, F., 219
 Solenoid, 19

Sounder, 94
 Spark, quenched, 164
 Sparking plug, 72
 Starting resistance, 42
 Stator, 65, 238
 Steel-facing, 135
 Storage cells, 136, 141
 Striations, 191
 Strutt, Hon. R. J., 219, 230
 Submarine cable, 108
 Suspended coil galvanometer, 95
 Synchronizing, 24
 Synchronous motor, 66, 238
 Syntony, 163

T

Tantalum, 79
 Telegraph, automatic, 101
 —, differential, 97
 —, diplex, 99
 —, duplex, 97
 —, multiplex, 100
 —, printing, 104
 —, quadruplex, 99
 —, simple, 92
 Telephone, Bell, 111
 —, transformer, 117
 Telephony, wireless, 180
 Thermionic valve, 174
 Thermionics, 206, 239
 Thomson, Elihu, 60, 165
 —, Sir Joseph J., 156, 193, 198
 —, Sir Wm., 10
 Three-wire system, 37, 239
 Transformer, 52, 56, 239
 —, telephone, 117
 Transmitter, telephone, 112, 239
 Triode, 175, 239
 Triode as generator, 179
 Tube, X-ray, 205
 —, Coolidge, 206
 Tubes of force, 154
 Tungsten, 79
 Tuning-fork, electric, 26

U

Ultra-violet, 160
 Unit, Board of Trade, 48

V

Valve, amplifying, 175, 177
 —, Nodon, 144
 —, rectifying, 174

Van 't Hoff, J. H., 129
Vibratory discharge of condenser, 151
Violle, 84
Volt, the, 239
Volta, Alessandro, 4
Voltmeter, 130, 239
—, copper, 131
—, silver, 131

W

Watt, 46, 239
Wattmeter, 46, 240

Welding, 60
Weston cell, 139
Wheatstone, 91
— automatic telegraph, 101
Wheatstone's bridge, 98, 240
Wien, M., 164
Wilson, C. T. R., 194, 212, 218
Wireless telephony, 180

X

X-rays, 199, 240
X-ray tube, 205

UNIVERSITY OF CALIFORNIA LIBRARY
BERKELEY

Return to desk from which borrowed.

This book is DUE on the last date stamped below.

6 Mar '50 HJ

9 Apr '51 AM

Mar 27 '51 LL

21 JUL '64 DY

REC'D LD

JUL 24 '64 -2 PM

APR 02 2000

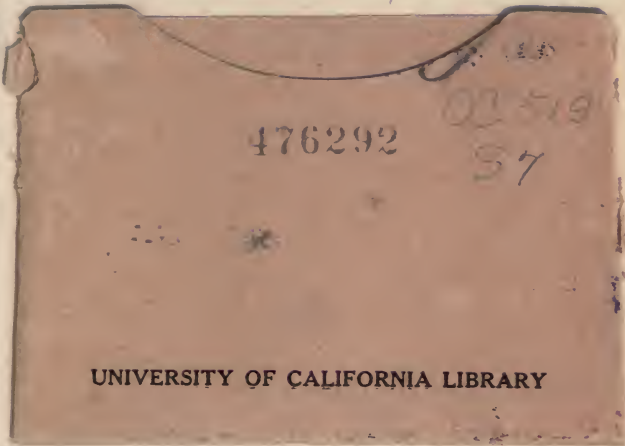

476292

Q2519
37

UNIVERSITY OF CALIFORNIA LIBRARY

